



Lab work in photonics

Quantum photonics

P1	Entangled photons and Bell's inequality	1	(N1.6)
P3	Hong, Ou and Mandel experiment	13	(N1.3)
P4	Second Harmonic Generation in a KDP crystal	23	(R1.61)

lense.institutoptique.fr / Troisième année/ Photonique 3A|M2

Engineer - 3rd year - Palaiseau
Master 2 QLMN

Year 2022-2023

M2 LOM Labwork

Entangled photons and Bell's inequality

Questions **Q1** to **Q8** have to be done before the class.

1 Introduction

Quantum theory doesn't allow one to calculate the outcome of a measurement, but rather the probability of the different possible outcomes. Because of this probabilistic aspect, many physicists, including Einstein, were dubious and thought that quantum mechanics had to be an incomplete theory that was not accounting for the full reality. To illustrate this point, Einstein, Podolski and Rosen presented in 1935 a "gedankenexperiment" (mental experiment) where a measurement on an entangled two-particle state (Bell state or EPR state) leads to a paradox, which the authors interpret as a proof of the incompleteness of the quantum theory^[1].

For a Bell state, a measurement of the state of each particle taken individually gives a random outcome, but the two results are perfectly correlated. In other words, a measurement of the first particle state allows us to predict with certainty the state of the second one. For Einstein, Podolsky and Rosen, the possibility of predicting the state of the second particle implies that this state exists before the measurement, implying that there is a set of « hidden » variables (in the sense that they are not described by the theory) that determine this state all along the experiment.

For a long time, it has seemed that the debate between a hidden variable interpretation and a purely probabilistic theory was a philosophical discussion. However, in 1964, John Bell^[2] showed that there were some cases where the two interpretations were leading to incompatible observations, and that it was possible to settle the debate with an experiment. But it has been necessary to wait 15 more years for the progress of **quantum optics** to be enough to implement this experiment with pairs of entangled

1. A. Einstein, B. Podolsky et N. Rosen, *Can Quantum-Mechanical Description of Physical Reality Be Considered Complete?*, Physical Review **47**, 777 (1935)

2. J. S. Bell, *On the Einstein-Podolsky-Rosen paradox*, Physics **1**, 195 (1964)

photons. The first unambiguous results have been obtained at the Institut d'Optique by Alain Aspect, Philippe Grangier and Jean Dalibard³.

This lab work, inspired by **M. W. Mitchell** and **D. Dehlinger**, aim to produce a two-photons Bell state, and allows you to determine, with your own measurements, which theory can be invalidate.

2 Bell states

2.1 Polarization state of a photon in quantum mechanic

When we measure the polarization of a photon with a vertical analyzer, we refer to the basis formed by the vertical polarization ($|V\rangle$ parallel to the analyzer axis) and the horizontal polarization ($|H\rangle$ orthogonal to the analyzer axis). In this basis, the polarization state is written :

$$|\psi\rangle = c_V|V\rangle + c_H|H\rangle. \quad (1)$$

The coefficients c_V and c_H are complex number such as $|c_V|^2 + |c_H|^2 = 1$. The measurement of the photon polarization can only gives two outcomes :

- The photon is transmitted by the polariser and its polarization state is projected on $|V\rangle$. Quantum mechanic predict that the probability of this result is $P_V = |\langle\psi|V\rangle|^2 = |c_V|^2$;
- The photon is blocked by the polariser and its polarization state is projected on $|H\rangle$. The associated probability is $P_H = |\langle\psi|H\rangle|^2 = |c_H|^2$.

Q1 Write the polarization state of a photon with a rectilinear polarization, at an angle α from the vertical. What is the probability to measure it in the state $|V\rangle$?

Q2 Write the polarization state of a photon with a left-circular polarization. What is the probability to measure it in the state $|V\rangle$?

If we choose to measure the polarization state of a photon with a polariser rotated by an angle α from the vertical, the new basis of the polarization state is $\{|V_\alpha\rangle, |H_\alpha\rangle\}$ (figure [1](#)).

Q3 Considere a photon in the polarzation state $|V\rangle$. Write its state in the basis $\{|V_\alpha\rangle, |H_\alpha\rangle\}$. What is the probability P_{V_α} of measuring the polarization V_α ?

2.2 Pairs of polarization entangled photons

During this lab work, you will produce and characterize pairs of polarization entangled photons. The polarization state of those pairs is a Bell state, written as follow :

3. See for instance : A. Aspect, J. Dalibard et G. Roger, *Experimental Test of Bell's Inequalities Using Time-Varying Analyzers*, Physical Review Letters **49**, 1804 (1982)

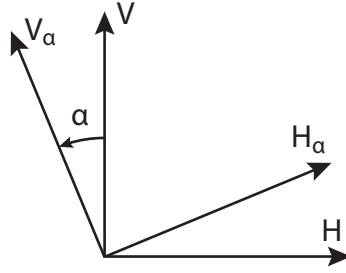

FIGURE 1: The basis of the polarization state $\{|V_\alpha\rangle, |H_\alpha\rangle\}$ is obtained by rotating the basis $\{|V\rangle, |H\rangle\}$ by an angle α .

$$|\psi\rangle = \frac{1}{\sqrt{2}} (|V,V\rangle + |H,H\rangle) . \quad (2)$$

It is a non separable state, which mean that we can not assign a polarization state to each photon individually.

Q4 Show that the probability P_V of measuring the photon 1 **or** the photon 2 in the polarization V is $1/2$.

Q5 What is the probability of measuring the two photons in the same polarization state (V,V or H,H)? What is the probability of measuring the two photons in orthogonal polarization states (V,H or H,V)?

In other words, a polarization measurement on one of the photons gives a random result, but if we measure the polarizations of the two photons of the pair, the results are always **correlated**. More generally, the probability to measure simultaneously the photon 1 in the polarization state V_α and the photon 2 in the polarization state V_β is given by

$$P(V_\alpha, V_\beta) = |\langle V_\alpha, V_\beta | \psi \rangle|^2 . \quad (3)$$

Q6 Show that $P(V_\alpha, V_\beta) = \cos^2(\alpha - \beta)/2$. How does this probability change when the two axis of analysis are rotated by the same angle?

Q7 Show that the Bell state has the same form than (2) no matter what the basis of analysis is, which mean that :

$$|\psi\rangle = \frac{1}{\sqrt{2}} (|V_\alpha, V_\alpha\rangle + |H_\alpha, H_\alpha\rangle) , \quad \forall \alpha . \quad (4)$$

This **rotational symmetry** of the polarization state is a crucial property of the Bell state that we will use to reveal the full extent of the correlation between the entangled photons.

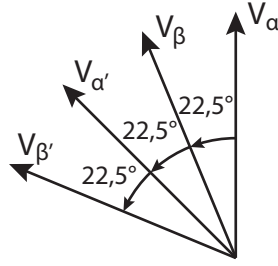

FIGURE 2: This set of angles of analysis maximizes the Bell parameter predicted by quantum mechanics.

2.3 Bell's inequality

For arbitrary orientated analyzers, the degree of correlation between the results of the measurements on the two photons can be quantified by the quantity

$$E(\alpha, \beta) = P(V_\alpha, V_\beta) + P(H_\alpha, H_\beta) - P(V_\alpha, H_\beta) - P(H_\alpha, V_\beta). \quad (5)$$

From this quantity, we can define the **Bell parameter** :

$$S(\alpha, \alpha', \beta, \beta') = E(\alpha, \beta) - E(\alpha, \beta') + E(\alpha', \beta) + E(\alpha', \beta'). \quad (6)$$

It is that parameter that allows one to distinguish between the hidden variable theory and the quantum theory. Indeed, Bell showed that according to the hidden variable theory, S should be lower than 2 no matter what is the state of the two photons. It is the so-called **Bell inequality**. On the other hand, the quantum theory predicts a value of S strictly greater than 2 for a Bell state, for a certain choice of angles of analysis.

Q8 Show that $S = 2\sqrt{2}$ for the set of angles of analysis depicted in figure 2. In this configuration, the Bell inequality are maximally violated by quantum mechanics.

3 Experimental implementation

3.1 Description of the experiment

The source of polarization-entangled photons consist in a laser diode emitting a 405 nm beam, vertically polarized and focused on two non-linear crystals of BBO. In those crystals, a parametric conversion process turn the 405 nm photons into a pair of 810 nm photons. One of the crystal can generate pairs of photons with a vertical polarization, and the other one generate a horizontally polarized pair. The twin photons are emitted symmetrically with respect to the probe beam, inside a cone with an aperture of about 3° . An half-wave plate working at 405 nm and a Babinet compensator allows one to adjust the polarization state of the probe beam.

To collect the infrared photons, we use an avalanche photodiode (APD) on both side of the emission cone. Before entering into the detector, the infrared photons go through

a polarization analyzer made of an half-wave plate, a polarization beam splitter (PBS), a lens to focus the beam onto the photodiode, and a interferential filter centered on 810 nm with a 10 nm width. A FPGA card is used to count the number of photons detected, as well as the number of coincidences, which correspond to a simultaneous detection on both arms. Those measurement are then displayed by a Labview code.

3.2 Single photons detection device

The detection devices are made of silicon APD used in single photon detection mode. On each arm A and B, the detection of a photon produce a TTL pulse (0–5 V) with a temporal width of 25 ns.

Warning! Those detectors are very, very expensive and would be destroyed by a strong photon flux! Always check that the black tubes and the filters are installed to protect the photodiodes. Wait for the teacher authorization to switch on the detectors, and make sure that the main lights are off and the door is closed.

3.3 Events and coincidences counters

The FPGA card counts the TTL pulses emitted by the detectors (after a conversion from 0–5 V to 0–3,3 V), and the number of coincidences between the A and B pulses within an adjustable integration time. To count the coincidences, the FPGA card proceed as follow : when a pulse arrive on channel A, a time window of adjustable duration is open ; if a pulse arrive on channel B before this window is closed, a coincidence is counted. The card send the counting information to the computer via a RS232 link, and the informations are displayed by a Labview code. All the connections are already done, and we payed attention to the fact that the cables linking the APD to the coincidence counters have the same length.

Q9 *Why do the cables need to have the same length?*

- Before doing anything else, switch on the FPGA card, then start the Labview program.
- Switch off every lights and turn the photons counters on.
- Measure the number of dark counts. The lower this number is, the better the detectors are.
- Switch a weak light on (not the one of the sealing!) and check that the number of detected photons stays way below 10^6 photons/s.

TABLE 1: Duration of the coincidence window.

SW16	SW17	τ (ns)
off	off	~ 70
on	off	~ 20
off	on	~ 14
on	on	~ 7

3.4 Number of accidental coincidences.

For now, since the light sources are chaotic, the photons arriving in A and B are not correlated, and therefore the potential coincidences that you might detect are accidental. We note n_A and n_B the **counting rate** (average number of photons per second) on channels A and B, n_f the rate of accidental coincidences, and τ , the duration of the coincidence window.

Q10 Show that the rate of accidental coincidence is given by : $n_f = n_A n_B \tau$.

The last two switches of the FPGA card, SW16 and SW17, allows one to choose the duration of the coincidence window (see table [1](#)). The number given by this table are approximative and need to be re-measured.

Q11 Measure the rate of accidental coincidences for each of the four configurations and calculate the durations of the four coincidence windows using the formula established in question [Q10](#).

This measure allows one to check the behavior of the coincidence counters. Call the teacher if the results are way different from the value of table [1](#).

3.5 Pump diode

The pump diode is a 405 nm laser with about 60 mW of output power. The light emitted by the diode is linearly polarized. The wearing of security glasses is mandatory !

- Press the two buttons to turn on the temperature regulator of the diode. The temperature is already set to obtain the correct wavelength. Don't try to change it.
- Press the two buttons to turn on the current supply of the diode, and set the current at maximum (about 95 mA).
- If they are present on the bench, remove the optical elements mounted before the BBO crystals (half-wave plates at 405 nm and Babinet compensator) as well as the half-wave plates at 810 nm and the PBS cubes in front of the detection channels.
- Check the alignment of the beams (they should be already well aligned).

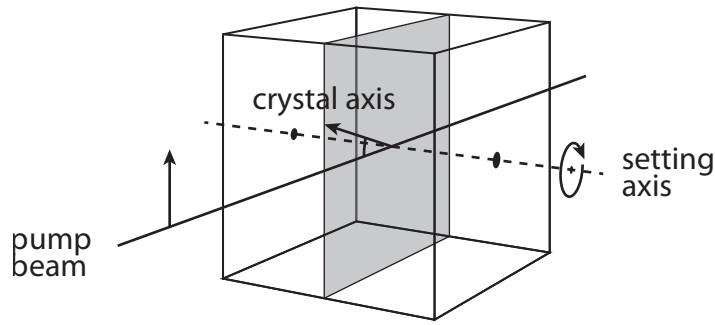

FIGURE 3: The optical axis of the crystal is oriented « vertically » with respect to the pump axis. The other crystal is oriented « horizontally ».

3.6 Parametric conversion

The photons pairs are produced by parametric conversion in non-linear crystals $\beta\text{-BaB}_2\text{O}_4$ (baryum β -borate, BBO for short). During the non-linear process, a photon coming from the 405 nm pump can be converted in a pair of twin 810 nm photons. The BBO is a negative uniaxial birefringent crystal. We use a type I phase matching, meaning that the twin photons have the same polarization.

The pump beam is orthogonal to the entrance plane of the crystals. The optical axis of the crystals make an angle of about 29° with the pump beam. The optical axis of the first crystal and the axis of the pump are forming a vertical plane, and the 810 nm twin photons emitted from this crystal are horizontally polarized (see figure 3). The optical axis of the second crystal and the axis of the pump are forming a horizontal plane, and the twin photons are emitted with a vertical polarization. In both cases, the twin photons are emitted symmetrically with respect to the pump axis, within a cone of about 3° of aperture.

Note : The direction of emission of the twin photons varies very quickly with the angle between the crystal own axis and the pump axis. To optimize the number of twin photons arriving onto the detectors, one should carefully set the orientation of the two crystals, using the horizontal and vertical screws of the mount (see figure 3).

3.7 Settings of the collimation lens

To efficiently detect the pairs, the waist of the pump beam (which is inside the BBO crystals) is imaged onto the APD's sensitive surface. It is a difficult setting because this surface has a diameter of $180\ \mu\text{m}$ only. The lenses have a focal length of 75 mm and a diameter of 12,7 mm. They are mounted 1040 mm away from the crystal.

Q12 Calculate the position of the image of the waist. Check that the APD are approximately at this position.

Q13 *What is the magnification? Give an estimation of the diameter of the waist, then check that the size of the sensitive area of the photodiode is not limiting.*

3.8 Optimization of the coincidence number

The direction of emission of the twin photons is very sensitive to the orientation of the crystals, which need to be carefully optimized. The pump beam being vertically polarized, only the crystal whose axis is in a vertical plane can satisfy the phase matching condition for now. Its orientation can be adjusted thanks to the horizontal screw.

Optimize the number of coincidences by tuning the screw.

Q14 *Calculate the number of accidental coincidences. Do we need to take it into account?*

Q15 *Calculate the ration between the number of coincidences and the number of photons detected on each channel. Comment?*

We will now try to optimize the orientation of the crystal whose axis is in an horizontal plane :

- Put the 405 nm half-wave plate before the BBO crystals.
- **Carefully identify the own axis of the plate (they do not correspond exactly to the 0 and 90° position). A good identification is crucial for the following.**
- Check that the number of coincidences is unchanged if the axis of the plate are horizontal and vertical. Explain why.
- Turn the plate at 45° to align the polarization of the pump beam with the horizontal axis.
- Optimize the number of coincidences by touching the vertical screw of the crystals.

3.9 810 nm polarization analyzer

Put the 810 nm half-wave plates and the PBS cubes on each channel. Together they form a polarization analyzer (see figure [4](#)).

warning : The angle of the analyser is equal to the angle of analysis divided by two. So be careful to distinguish the angle of analysis from the angle of the plate!

Q16 *Show that when the plate is vertical, the analyzer transmit the horizontal polarization, and therefore allows to detect the $|H\rangle$ photons. How much do you need to turn the plate to detect $|V\rangle$ photons?*

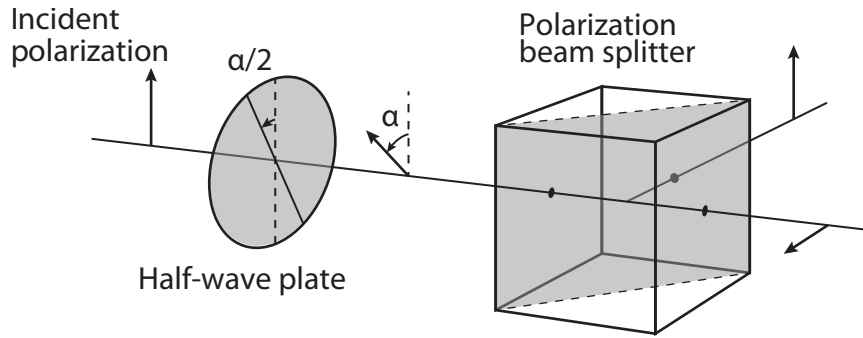

FIGURE 4: The polarization analyzer is made of an half-wave plate (whose orientation is adjustable) and a PBS cube.

- Check experimentally that the twin photons are in the state $|H\rangle_1 |H\rangle_2$ if the 405 nm half wave plate is vertical, and in the state $|V\rangle_1 |V\rangle_2$ if the plate is rotated by 45° .
- If necessary, turn again the screws of the BBO crystals to have approximatively the same number of coincidences for those two positions of the plate.
- Then set the plate to $22,5^\circ$ (try to be very precise) to obtain approximatively the same number of coincidences with the two analyzers in vertical position and the two analyzers in horizontal position (it is impossible to obtain a perfect equality, but try to balance the coincidences as much as you can).

Q17 Measure the number of coincidences when the two analyzers are parallel (horizontally or vertically). Measure the number of coincidences when the two analyzers are orthogonal. Explain your observations.

The previous settings allow you to obtain pairs of photons, created in one of the two BBO crystals with the same probability. Now you need to precisely adjust the polarisation state of the pump beam to obtain a Bell state.

3.10 Realization of a Bell state

For now, your twin photons are in the state

$$|\psi\rangle = \frac{1}{\sqrt{2}} (|V,V\rangle + e^{i\phi}|H,H\rangle) . \quad (7)$$

Where ϕ is the phase difference between the twin photons horizontally polarized, and the twin photons vertically polarized. This phase difference is linked to the birefringence of the BBO crystals.

Q18 Calculate the join probability $P(V,V)$ and $P(H,H)$ for the state (7). Does it allows you to distinguish the state (7) from the Bell state (2) ?

Q19 Show that $P(V_{45^\circ}, V_{45^\circ}) = (1 + \cos(\phi))/4$. What is the difference with the Bell state ?

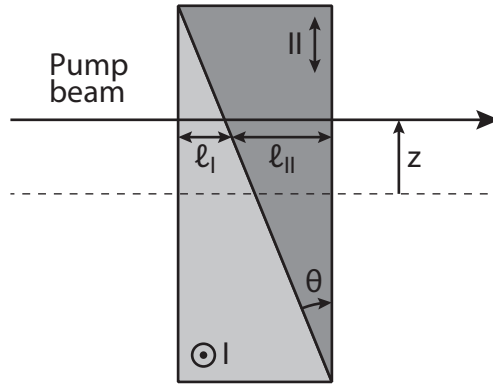

FIGURE 5: The Babinet compensator consist in two pieces of uniaxial birefringent crystal. The pieces are beveled and mounted one against the other, in such a way that the optical axis of the two crystals are orthogonal (and both parallel to the entrance plane). If we note n_1 the refractive index along the optical axis, and n_2 the refractive index along the direction orthogonal to the optical axis, we see that the dephasing $\phi_B = \phi_H - \phi_V$ accumulated between the polarisation components of a beam with a wavelength λ is given by $\lambda\phi_B/2\pi = (n_2\ell_I + n_1\ell_{II}) - (n_1\ell_I + n_2\ell_{II}) = 2(n_2 - n_1) \tan(\theta) z$.

To obtain a Bell state instead of the state (7), you need to compensate the dephasing ϕ , by using a Babinet compensator. If the axis of the compensator match the horizontal and the vertical direction, you can translate it orthogonally to the pump axis to linearly vary the dephasing between the two polarisation components (see figure 5). For the pump wavelength, this dephasing typically vary of 2π for a translation of about 5 mm.

- Mount the compensator on the bench.
- Check that the coincidence rate are still equal when the analyzers are parallel horizontally and vertically. If it is not the case, it means that the axis of the compensator do not match the vertical and horizontal directions, and you need to slightly rotate the compensator.

Q20 Put the analyzers at 45° on both channels and plot the coincidence rate as a function of the compensator translation over 10 mm (by step of 0,5 mm). Take an integration time of 10 s.

Q21 Does the curve behave as expected? Comment on the contrast.

Q22 What are the points of the curve corresponding to a compensation of the dephasing induced by the crystals?

3.11 Variation of the join probability

The two theories we want to test (quantum theory and local hidden variable theory) do not predict the same variation of the join probability $P(V_\alpha, V_\beta)$ as a function of the

relative angle $\alpha - \beta$. So it is interesting to measure it. Experimentally, we can estimate the probability $P(V_\alpha, V_\beta)$ by setting the analyzers at α and β and calculating the ratio between the coincidence rate and the photon rate on each channel.

Q23 Fix the angle of one of the two analyzers at \mathcal{O}° and plot the variation of the coincidence rate as a function of the angle of the second analyzer. During this measurement, check that the photon rate on each channel remains approximatively constant. Re-do the same measurement, but this time set the first angle to 45° . Compare those measurements to the prediction of quantum mechanics (question [Q6](#)).

3.12 Measure of the Bell parameter

You will now experimentally evaluate the Bell parameter defined by the relation [\(6\)](#), and whose value may allows you to invalidate the local hidden variable theory. To do so, you will measure the join probabilities $P(V_\alpha, V_\beta)$, $P(H_\alpha, H_\beta)$, $P(V_\alpha, H_\beta)$ and $P(H_\alpha, V_\beta)$ for the following set of angles of analysis : $\{\alpha, \beta\}$, $\{\alpha, \beta'\}$, $\{\alpha', \beta\}$ and $\{\alpha', \beta'\}$ define on figure [2](#).

To minimize the uncertainty of each measurement, one need to maximize the number of coincidences detected, so one need to count them during a longer time. Indeed, the fluctuations of the number of coincidences detected N_c during an interval T are linked to the photon "shot noise", which has a poissonian statistic. It means that the statistic uncertainty (standard deviation) $\sigma[n_c]$ on the coincidence rate $n_c = N_c/T$ verifies :

$$\sigma[n_c] = \frac{\sigma(N_c)}{T} = \frac{\sqrt{N_c}}{T} = \sqrt{\frac{n_c}{T}}, \quad (8)$$

so that the relative uncertainty

$$\frac{\sigma[n_c]}{n_c} = \frac{1}{\sqrt{N_c}} = \frac{1}{\sqrt{n_c T}}. \quad (9)$$

Q24 If you count an average of 100 coincidences/s, what is the standard deviation of the coincidence rate ? For how long you need to count to divide this standard deviation by 10 ?

Fill the Excel chart on the computer for each of the 16 measurements. Take an integration time of 10 or 20s to have a good precision. The Bell parameter is then automatically calculated.

Q25 What value of the Bell parameter do you obtain and what are the error bars ? Does your measurement allows you to invalidate the local hidden variable theory or the quantum theory ?

Q26 What result would allow you to invalidate quantum mechanic ?

M2 LOM Labwork

Hong, Ou and Mandel experiment

The Hong, Ou and Mandel (HOM) experiment, conducted in 1987^[1], was the first observation of a quantum interference between two photons. This phenomenon appears when two indistinguishable photons arrive simultaneously at the two input of a 50/50 beam splitter. The distribution of the two photons between the two output of the beam splitter exhibit a surprising behavior, that can not be explained with a classical theory of light...

1 The HOM effect

1.1 Description of the phenomenon

If a photon arrive on a beam splitter, there is a $1/2$ probability of being transmitted or reflected. When two photons arrive simultaneously on a beam splitter, each one at a different input (a or b), there are four possibilities (see figure ^[1]) :

- The photon entered in a goes out in c , and the photon entered in b goes out in d ;
- The photon entered in a goes out in d , and the photon entered in b goes out in c ;
- Both photons go out in c ;
- Both photons go out in d .

If the photons were classical particles, the 4 cases would always be equiprobable, in the case where the reflectivity and transmittivity of the beam splitter are equal. But according to the quantum theory, if the two particles are **indistinguishable** (and in our case it means that the properties of the photons are identical : polarization, frequency, transverse mode) there is no way to know which particle is which at the output of the beam splitter, and therefore there is only 3 possible **observations** :

1. C. K. Hong, Z. Y. Ou et L. Mandel, *Measurement of subpicosecond time intervals between two photons by interference*, Physical Review Letters **59**, 2044 (1987)

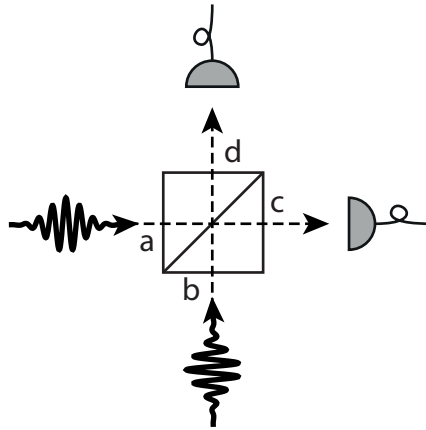

FIGURE 1: Two indistinguishable photons arrive simultaneously on a beam splitter. Two single-photon detectors at the output c and d record which way the photons went out.

- we observe one photon in each output ;
- we observe two photons in output c ;
- we observe two photons in output d .

Then, according to quantum mechanics, the probability of observing a photon in each output results from the **interference** between the two **classical trajectories** $(a, b) \rightarrow (c, d)$ and $(a, b) \rightarrow (d, c)$. It then depends on the **relative phase** associated to those trajectories.

1.2 Formalism

In classical electromagnetism, a beam splitter is modeled by a **real unitary matrix** , that links the **electrical fields** $\mathcal{E}_{a,b}$ of the inputs to the electrical fields $\mathcal{E}_{c,d}$ of the outputs :

$$\begin{pmatrix} \mathcal{E}_c \\ \mathcal{E}_d \end{pmatrix} = U \begin{pmatrix} \mathcal{E}_a \\ \mathcal{E}_b \end{pmatrix} \quad \text{with} \quad U = \begin{pmatrix} t & r \\ -r & t \end{pmatrix}. \quad (1)$$

The unitarity property $U^\dagger U = \mathbb{1}$ stands for the **energy conservation** between the input and the output of the beamsplitter. It leads to a relationship between the reflectivity and transmittivity coefficient of the beam splitter.

$$r^2 + t^2 = 1. \quad (2)$$

A 50/50 beam splitter corresponds to the case where $r = t = 1/\sqrt{2}$.

In the quantum optics formalism, the complex electromagnetic field is replaced by **creation and annihilation operators** :

$$\mathcal{E}_a \rightarrow \{\hat{a}, \hat{a}^\dagger\}, \quad \mathcal{E}_b \rightarrow \{\hat{b}, \hat{b}^\dagger\}, \quad \mathcal{E}_c \rightarrow \{\hat{c}, \hat{c}^\dagger\}, \quad \mathcal{E}_d \rightarrow \{\hat{d}, \hat{d}^\dagger\}. \quad (3)$$

The beam splitter links those operators in the same way than with the electric fields :

$$\begin{pmatrix} \hat{c} \\ \hat{d} \end{pmatrix} = U \begin{pmatrix} \hat{a} \\ \hat{b} \end{pmatrix} \quad \text{and} \quad \begin{pmatrix} \hat{c}^\dagger \\ \hat{d}^\dagger \end{pmatrix} = U \begin{pmatrix} \hat{a}^\dagger \\ \hat{b}^\dagger \end{pmatrix}. \quad (4)$$

The unitarity property of the matrix U ensures that **the number of photons is conserved** between the input and the output :

$$\hat{c}^\dagger \hat{c} + \hat{d}^\dagger \hat{d} = \hat{a}^\dagger \hat{a} + \hat{b}^\dagger \hat{b}. \quad (5)$$

The quantum state that corresponds to a situation where two photons enter in a and b is obtained by using the operators \hat{a}^\dagger and \hat{b}^\dagger on the state which corresponds to the **electromagnetic vacuum** : $\hat{a}^\dagger \hat{b}^\dagger |\text{vacuum}\rangle$. By inverting the relation [4](#), one can link this input state to the output state :

$$\begin{aligned} \hat{a}^\dagger \hat{b}^\dagger |\text{vacuum}\rangle &= (t\hat{c}^\dagger - r\hat{d}^\dagger)(r\hat{c}^\dagger + t\hat{d}^\dagger) |\text{vacuum}\rangle \\ &= (tr\hat{c}^\dagger \hat{c}^\dagger + t^2\hat{c}^\dagger \hat{d}^\dagger - r^2\hat{d}^\dagger \hat{c}^\dagger - rt\hat{d}^\dagger \hat{d}^\dagger) |\text{vacuum}\rangle. \end{aligned} \quad (6)$$

In the case of a 50/50 beam splitter, we can use the commutativity of the operators acting on the different modes of the electromagnetic field. The last expression then become :

$$\hat{a}^\dagger \hat{b}^\dagger |\text{vacuum}\rangle = \frac{1}{2}(\hat{c}^\dagger \hat{c}^\dagger - \hat{d}^\dagger \hat{d}^\dagger) |\text{vacuum}\rangle. \quad (7)$$

The interpretation of this equation is straightforward : at the output of the beam splitter, the states corresponding to the situation where two photons are at the output c or d are equiprobable, but the probability of having a photon on each output is zero. Therefore **we never observe any coincidence** between the detectors c and d .

2 Experimental realization

2.1 Description of the experimental setup

To observe the HOM effect, one needs to create pairs of indistinguishable photons and send them into a beam splitter (see figure [2](#)). To do so, we will use a parametric down-conversion process inside a $\chi^{(2)}$ non-linear crystal (BBO) than can convert a pump photon at $\lambda_p = 405 \text{ nm}$ into a pair of photons at $2\lambda_p = 810 \text{ nm}$. The twin photons are emitted symmetrically with respect to the pump axis, within a cone of about 3° of aperture. The pump beam, emitted from a laser diode, is horizontally polarized. The twin photons created in this process, are vertically polarized.

The twin photons are then injected inside two polarization-maintaining monomode fibers, thanks to a pair of fibered collimators and an optical doublet, whose focal point is set inside the crystal. An interferometric filter at 810 nm allows us to get rid of most

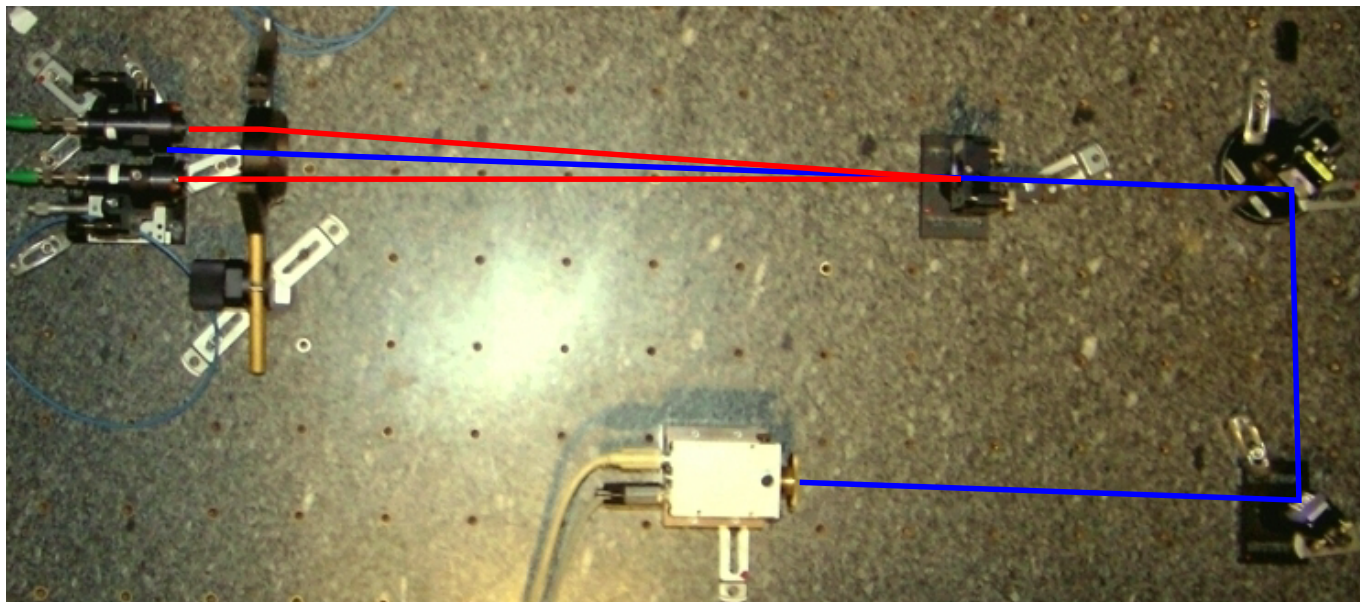

FIGURE 2: View from above. We see the laser diode, two mirrors to set the alignment, the non-linear crystal, the optics for the conjugation and two fibered collimators. The optical path of the pump beam and the photons pairs are sketched.

of the stray lights. The fibered light then enters inside a module made of two waveguides that will play the role of the beam splitter. The waveguides are mounted very close to each other so that the transverse mode of the light propagating in each waveguide overlap the other one. The fibers are connected to a detection module using Avalanche PhotoDiodes (APD). A FPGA card is used to count the number of detected photons in each output. A simultaneous detection on each output is counted as a **coincidence**. A Labview code is then used to display the number of events and coincidences.

2.2 Single photon detection module

The single photon detection module is an exceptional tool, adapted for this kind of experiment. It is made of four fibered channels, linked to four APDs. On each channel, the detection of a photon triggers the emission of a 25 ns TTL pulse (0–5 V). We will just use two channels out of four for this experiment, labeled *A* and *B*.

Warning! Those detectors are very, very expensive and would be destroyed by a strong photon flux! Always check that the interferometric filters are installed to protect the photodiodes. Wait for the teacher authorization to switch on the detectors, and make sure that the main lights are off and the door is closed.

TABLE 1: Duration of the coincidence window.

SW16	SW17	τ (ns)
off	off	~ 50
on	off	~ 20
off	on	~ 14
on	on	~ 7

2.3 Event and Coincidence counter

The FPGA card counts the TTL pulses emitted by the detectors (after a conversion from 0–5 V to 0–3,3 V), and the number of coincidences between the A and B pulses within an adjustable integration time. To count the coincidences, the FPGA card proceed as follow : when a pulse arrive on channel A, a time window of adjustable duration is open ; if a pulse arrives on channel B before this window is closed, a coincidence is counted. The card send the counting information to the computer via a RS232 link, and the informations are displayed by a Labview code. All the connections are already done, and we payed attention to the fact that the cables linking the APD to the coincidence counters have the same length.

Q1 *Why do the cables need to have the same length ?*

- Before doing anything else, switch on the FPGA card, then start the Labview program.
- Switch off every lights and turn the photons counters on.
- Measure the number of dark counts. The lower this number, the better the detectors are.
- Switch on a weak light (not the one of the sealing!) and check that the number of detected photons stays way below 10^6 photons/s.

2.4 Number of accidental coincidences.

For now, since the light sources are chaotic, the photons arriving in A and B are not correlated, and therefore the coincidences are accidental. We note n_A and n_B the **counting rate** (average number of photons per second) on channels A and B, n_f the rate of accidental coincidence, and τ , the duration of the coincidence window.

Q2 *Show that the rate of accidental coincidence is given by : $n_f = n_A n_B \tau$.*

The last two switches of the FPGA card, SW16 and SW17, allows one to choose the duration of the coincidence window (see table [1](#)). The number given by this table, are approximative and need to be re-measured.

Q3 Measure the rate of accidental coincidence for each of the four configurations and calculate the durations of the four coincidence windows using the formula established in question [Q2](#).

This measure allows one to check the behavior of the coincidence counters. Call the teacher if the results are way different from the value of table [1](#).

2.5 Pump diode

The pump diode is a 405 nm laser with about 60 mW of output power. The light emitted by the diode is linearly polarized. The wearing of security glasses is mandatory!

- Press the two buttons to turn on the temperature regulator of the diode. The temperature is already set to obtain the correct wavelength. Don't try to change it.
- Press the two buttons to turn on the current supply of the diode, and set the current at maximum (about 95 mA).
- Briefly check the alignment of the beams (they should be already well aligned).

2.6 Parametric conversion

The photons pairs are produced by parametric conversion in non-linear crystals β -BaB₂O₄ (baryum β -borate, BBO for short). During the non-linear process, a photon coming from the 405 nm pump can be converted in a pair of twin 810 nm photons. The BBO is a negative uniaxial birefringent crystal. We use a type I phase matching, meaning that the twin photons have the same polarization.

Q4 Recall what are the two conditions satisfied by a non-linear process. Which one is called the phase matching condition?

The pump beam is orthogonal to the entrance plane of the crystal. The optical axis of the crystal and the axis of the pump are forming an horizontal plane (see figure [3](#)). The pump is horizontally (extraordinary) polarized and the 810 nm twin photons emitted from the crystal are vertically (ordinary) polarized. The refractive indexes n_1 and n_2 which characterize respectively the crystal axis and the orthogonal axis are given in table [2](#). From those indexes, one can calculate the ordinary n_o and extraordinary n_e indexes saw by the pump while it propagates through the crystal :

$$n_o = n_1, \tag{8}$$

$$1/n_e^2 = \sin^2(\theta)/n_1^2 + \cos^2(\theta)/n_2^2. \tag{9}$$

θ being the angle between the propagation axis and the crystal axis (see figure [3](#)).

Q5 Explain how to find those relations, starting from the index ellipsoid.

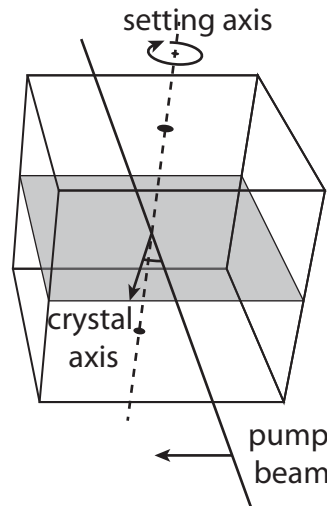

FIGURE 3: Orientation of the optical axis of the crystal with respect to the pump axis.

TABLE 2: Refractive index of the BBO crystal along its optical axis, at a temperature of 293 K.

wavelength (nm)	n_1	n_2
405	1,691 835	1,567 071
810	1,660 100	1,544 019

Q6 Give the relation between the angle θ and the emission angle of the twin photons inside the crystal, and outside the crystal (the angle between the wave vector and the pump axis).

Q7 The collimators are positioned in such a way that they are forming with the crystal an isosceles triangle, with a \mathcal{P} aperture. What should be the angle θ for the twin photons to be correctly collected by the collimators?

Q8 What would be the emission angle of the twin photons outside the crystal if we vary the angle θ of $\pm 1^\circ$? Comment.

2.7 Settings of the collimators

The optical fibers are polarization-maintaining fibers. Their own axis are parallel to the horizontal and vertical axis. One of the own axis can be spotted thanks to a tip on the connector.

Q9 Why are those polarization-maintaining fibers crucial to observe the HOM effect?

Now you need to image the area of emission of the photons pairs onto the core of each fibers, by tuning the orientation of the collimators. This is a difficult setting because the fibers' cores have a diameter of $5\ \mu\text{m}$ only. A good trick to do is to make

light propagates in the other direction (from the collimators to the crystal) by injecting a 670 nm auxiliary laser at the output of the polarization-maintaining fibers. You then have two beams coming out of the collimator. Focalise them inside the crystal and superimpose them to the pump beam. Of course you need to take the filter away from the collimator because they would cut the 670 nm light. Don't forget to put them back before switching the photon counters on again.

Warning! You must switch the single photon detection module off every time the fibers are disconnected, and every time the filter are taken away from the collimators. Don't forget to put them back before switching the photon counters on again. Always protect the fibers' extremity with a cap.

Even with this method, it is difficult to inject the fibers. You will have to be very cautious (and probably try several times) to set the collimators correctly. However, as soon as you manage to inject a small fraction of the twin photons, the setting becomes a lot easier, you then just have to optimize the number of coincidences by fine-tuning the position of the collimators.

Remark The screws of the collimators' mounts are the only elements you need to touch during this setting. If you lose all the signal in the process (and you are not able to recover it) call the teacher.

2.8 Optimization of the number of coincidences

The crystal orientation (i.e. the orientation of its optical axis) rapidly modifies the direction of emission of the twin photons, and so it has to be carefully tuned. Use the horizontal's screw of the crystal's mount to do so.

Q10 *What is the number of coincidences you can obtain? Calculate the rate of accidental coincidence. Do you need to take them into account?*

Q11 *Calculate the ratio between the number of coincidences, and the rate of detected photon on each channel. What is this quantity?*

2.9 Observation of the HOM effect

Once the coincidence rate is high enough (about 600 coincidences/s), you are ready to observe the HOM effect. One of the collimators is mounted onto a translation stage. Record the number of coincidences as you gently move the translation stage (for instance by step of 10 μm).

To lower the uncertainty of your measurements, you need to raise the number of detected coincidences, so you need to count them during a longer time. The fluctuations of the number of coincidences N_c measured during a time T is linked to the photons

shot noise, which follows a poissonian law. It means that the standard deviation $\sigma[n_c]$ on the coincidence rate $n_c = N_c/T$ verifies :

$$\sigma[n_c] = \frac{\sigma(N_c)}{T} = \frac{\sqrt{N_c}}{T} = \sqrt{\frac{n_c}{T}}, \quad (10)$$

which leads to the relative uncertainty :

$$\frac{\sigma[n_c]}{n_c} = \frac{1}{\sqrt{N_c}} = \frac{1}{\sqrt{n_c T}}. \quad (11)$$

Q12 *Assuming you count an average of 100 coincidences/s, what is the standard deviation on the coincidence rate? For how long do we need to count to reduce this deviation by a factor of 10?*

In practice, you will count the coincidences during a time interval of 10 or 20 s.

Q13 *Plot the coincidence rate as a function of the position of the translation stage. Add the error bars on your graph.*

Q14 *Interpret the curve.*

Q15 *What is the depth of the hole? Why does it not go to zero?*

Q16 *What is the the full width at half minimum of the hole? Compare it to the coherence length of the 810 nm photons, which is given by the the filter (10 nm width).*

Q17 *Explain why we describe the HOM effect as a « two photons interference »? What is the quantity that is interfering?*

The Hong, Ou et Mandel article describes for the first time this experiment and its results. It is interesting to notice that the paper's title really emphasis the "measurement of sub pico-second time intervals". It took time for the authors to realize the full extent of their discovery.

Q18 *Explain why this experiment is a powerful tool to measure extremely small time intervals.*

The photons you have sent on the beam splitter are twin photons created from a single pump photon. In that sense, the fact that they are indistinguishable might seems logical (but remember we saw that one could distinguish the photons by introducing a delay in the path of one of them).

Q19 *Do you think that two photons emitted independently, for instance by spontaneous emission from two different atoms, could be indistinguishable?*

For this last question, you can read the work done at the Institut d'Optiques by Antoine Browaeys and Philippe Grangier : J. Beugnon *et al.*, *Quantum interference between two single photons emitted by independently trapped atoms*, Nature **440**, 779 (2006).

Non-linear Optics

Second Harmonic Generation in a KDP crystal

In this session, we study the second harmonic generation process in a non-linear crystal (KDP crystal). We will use a pulsed Nd:YAG @ 1064 nm from laser to produce light @ 532 nm. The KDP crystal is a 30 mm diameter, 5 mm thick disk. KDP (**potassium dihydrogen phosphate**) is a birefringent negative uniaxial crystal. It has been cut so its optical axis is perpendicular to the entrance face. This axis is denoted as OZ.

The crystal axes frame is denoted as (X,Y,Z)

The lab axes frame is denoted as (O,x,y,z). Oz is the propagation direction of the different waves.

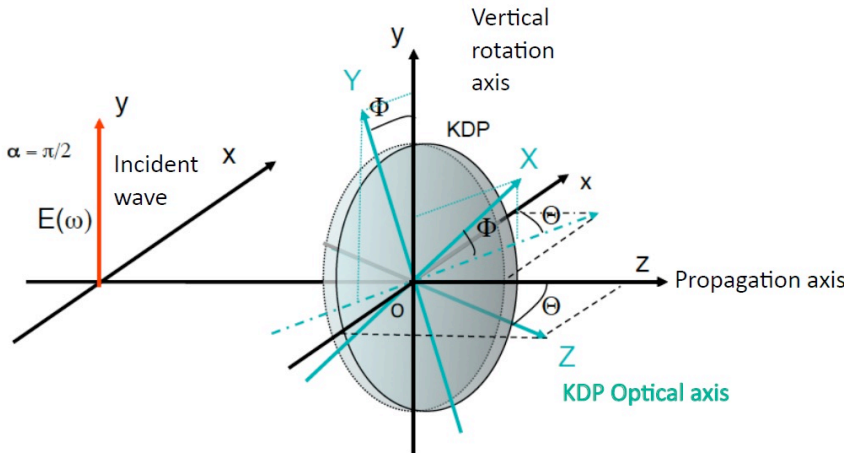

Figure 1 : Sketch of the crystal (the crystal is a disk). The crystal axes frame is $(O X, Y, Z)$
 θ is the crystal rotation angle around Oy (vertical axis of the mount),
 Φ is the rotation angle around OZ (crystal optical axis)

Several mechanical settings allows to move the crystal :

- The KDP disk can be rotated around the vertical axis (Oy). This will adjust the angle θ between the incident beam (Oz) and the optical axis (OZ). This angle θ is the phase-matching angle.
- It can also be rotated around its own axis OZ in order to modify the azimuth angle Φ .

The Nd:YAG laser is horizontally, linearly polarized. A half wave plate is used to rotate the incident polarization direction on the crystal. The angle α measures the angle between this direction with respect to the vertical axis. In our configuration, the incidence plane will always be defined by Oz and OZ : it is horizontal. The extraordinary direction of polarization is given by the projection of the crystal optical axis (OZ) on the plane wavefront : the extraordinary direction of polarization is then also horizontal. Therefore, the neutral axes will not be affected by a rotation around OZ and a modification of the azimuth angle Φ .

The complete setup gives us an easy access to three degrees of freedom in order to study SHG with respect to several orientations :

- the type I and type II phase matching conditions (angle θ)
- the influence of the crystal orientation (angle Φ)
- the influence of the pump beam polarization (angle α).

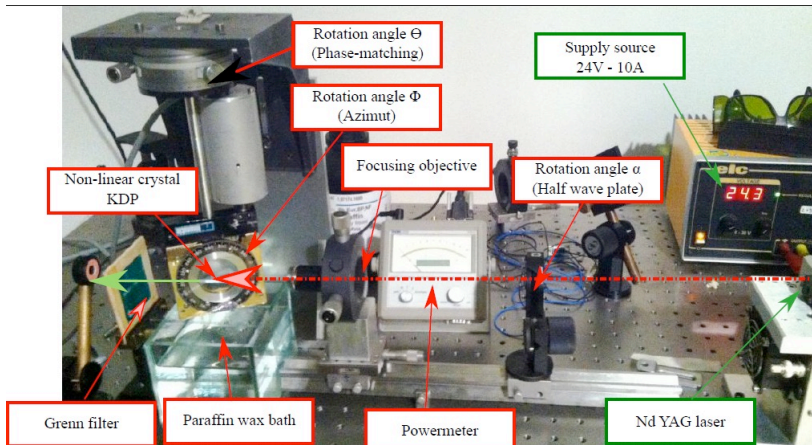

Figure 2 : picture of the setup

1. Type I phase matching :

Theoretical study :

Two conditions must be fulfilled by a non-linear process : energy conservation and momentum conservation. In the specific case of SHG, the momentum conservation can be written : $\vec{k}_{2\omega} = \vec{k}_{\omega} + \vec{k}_{\omega}$

where ω is the angular frequency of the fundamental wave and 2ω , the frequency doubled wave angular frequency. This relation is commonly known as the phase matching condition. For now, we study type I collinear phase matching , meaning that both incident fundamental wave vectors are the same.

QA.1 : KDP is a negative uniaxial crystal. Show that the type I phase matching condition can be expressed as :

$n_{e,2\omega}(\Theta) = n_{o,\omega}$, where $n_{e,2\omega}(\Theta)$ is the extraordinary optical index as seen by a frequency doubled wave that propagates with an angle theta with respect to the optical axis.

QA.2 : Use Figure 3 to propose a method to determine experimentally the phase matching angle Θ .

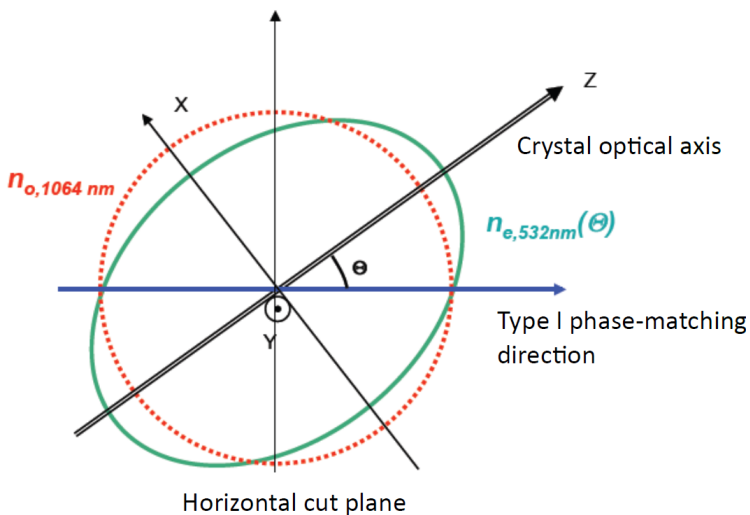

Figure 3 : Index surfaces in the KDP in the (horizontal) incidence plane.
Type I phase-matching

This angle can also be computed from the values of the extraordinary and ordinary indices given by the following Sellmeier equations :

$$n_o^2(\lambda) = 2.25976 + \frac{0.01008956\lambda^2}{\lambda^2 - 0.01294625} + \frac{13.00522\lambda^2}{\lambda^2 - 400}$$

$$n_e^2(\lambda) = 2.132668 + \frac{0.08637494\lambda^2}{\lambda^2 - 0.012281043} + \frac{3.227994\lambda^2}{\lambda^2 - 400}$$

The KDP crystal is a uniaxial negative crystal. We give the following values for the optical indices @ 1064nm and @ 532nm :

$$n_o(1064) = 1,49384 \qquad n_e(1064) = 1,45985$$

$$n_o(532) = 1,51242 \qquad n_e(532) = 1,47041$$

Use the index surface equation to show that the extraordinary index for a wave propagating with an angle theta can be deduced from the relation :

$$\frac{1}{n_{e,2\omega}^2(\Theta)} = \frac{\sin^2 \Theta}{n_{e,2\omega}^2} + \frac{\cos^2 \Theta}{n_{o,2\omega}^2}$$

QA.3 : Give an expression for the type I phase matching angle Θ , as a function of the ordinary and extraordinary optical indices

Experimental study of type I phase matching :

☠ Be careful !

The pump laser emits an invisible IR beam at 1064 nm, and its average optical power can be set as high as 100 mW. The pulse duration is 400 ps, meaning the peak power during the pulses reach 250 kW. The repetition rate of the laser can be adjusted between 0 and 1 kHz.

- Always wear safety goggles (type B).
- When not using it, please use the shutter to close the output of the laser.
- Please manipulate all components with care, including the paraffin wax filled aquarium.

☞ First, switch on the laser.

- Switch on the supply at 20V and 10A (button on the right)

- Switch on the pulse generator : set the period of the pulses around 14 ms. This choice for the period will prevent residual absorption in the paraffin wax and any subsequent thermal effects.
- Switch on the laser itself (« ON » switch on the side, then in front of the system (push twice this last button).
- Open the mechanical shutter (and remember to close it as soon as you do not use the laser).
- Check the output beam with the IR detection card.

☞ Paraffin wax bath :

The crystal is immersed in an immersion oil, with an optical index very close from the optical index of the KDP (paraffin wax optical index = 1,47). Therefore, the fundamental beam is not deviated when propagating through the interface (see Fig 4.) The crystal rotation angle around O_y is then directly linked to the angle between the pump beam and the crystal optical axis of the KDP.

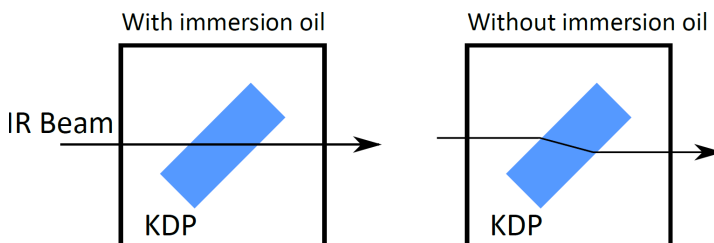

Figure 4 : Deviation of the IR beam in the crystal when the KDP crystal is or is not immersed in the paraffin wax bath.

☞ Crystal position :

☞ Set the axes (X,Y) of the crystal at 45° with respect to the vertical direction (we will explain later what this configuration is chosen here).

☞ Move the crystal rotation stage O_y at 45° with respect to the normal incidence.

☞ Move slightly the crystal around this position in order to observe a green beam. You will probably observe first fringes with the green beam. By adjusting the crystal position, make those fringes disappear. The crystal is then in the correct position.

QB.1 : Explain the physical origin of the fringes.

☞ Now adjust the position of the focusing objective in order to maximize the green beam intensity.

☞ Same with the half wave plate orientations

☞ ...and finally, same with the angle Φ

QB.2 : Check the green beam polarization direction with respect to the axis Oxyz with an analyzer, and confront this observation to the theoretical predictions.

QB.3 : Experimental measure of the phase matching angle.

As seen on fig 3, there are two valid directions corresponding to the phase matching angle. Both are symmetric with respect to the optical axis of the crystal. You will successively measure those two angular positions in order to get a better precision on your measurement. Give an experimental value for the phase matching angle, with its uncertainty, and compare it with the theoretical predictions.

QB.4 : Influence of the azimuth angle Φ .

For the KDP in type I phase matching, we can show that the non-linear polarization of interest in our problem can be expressed as :

$$P_x^{NL}(2\omega) = \varepsilon_0 \chi_{eff}^{(2)} E_y^2(\omega) \text{ avec } \chi_{eff}^{(2)}(2\omega, \omega, \omega) = 2d_{36} \sin(\Theta) \sin(2\Phi).$$

In the weak depletion regime, the power of the frequency-doubled beam $P_{2\omega}$

(expressed in watts) is proportional to : $P_{2\omega} = K \left(\chi_{eff}^{(2)} \right)^2 P_{\omega}^2$, where P_{ω} is the power of the fundamental beam (polarized along Oy). K is a proportionality coefficient that is a function of the optical indices, and of other parameters in the experiment (crystal length, waist of the fundamental beam...).

In the previous equation, Θ est fixé par les conditions d'accord de phase. However, Φ can be still be modified, independently of Θ . By using a

powermeter (with a green beam on the path of the beam), measure the optical power @ 532 nm as a function of angle Φ . You will have to readjust the angle Θ for each position of Φ , as the rotation axis of the stage is not exactly the optical axis. You will also have to remove the contribution of the stray light to the measured power. You can extinguish the green beam, either by rotating the incident polarization with the half wave plate, or by matching the condition $\sin(2\Phi)=0$.

Plot $P_{2\omega}=f(\Phi)$ and comment on the observed behavior.

QB.5 : Influence of the incident polarization

The type I phase-matching conditions are only fulfilled by the component of the field @1064 nm that is ordinary polarized (along the Oy axis of the setup). If the polarization is rotated by an angle α with respect to Oy , one must consider the projection on this axis. $E_y(\omega) = E_{incident}(\omega) \cdot \cos \alpha$. The useful part of the fundamental beam power is thus $P_{\omega Oy} = P_{\omega} \cos^2 \alpha$.

Use the powermeter to measure $P_{2\omega}=f(\alpha)$ and plot the corresponding curve. Comment on the observed behavior.

QB.6 : Angular acceptance

Use the camera to observe the light beam spots on the wall, at the output of the setup. The camera can see radiation @1064nm, so you can compare both wavelengths spots.

Be careful, and never place the camera directly in the beam !

Explain the slight ellipsoidal shape of the frequency doubled beam spot. Evaluate the divergence of the green beam along its smaller dimension by measuring the lateral size of the beam along its propagation direction with a screen (sheet of paper).

Deduce an estimation of the angular acceptance and compare to the theoretical value : 3.7 mrad.cm

2 Theoretical study of type II phase matching :

For type II phase matching, the momentum conservation can be expressed

$$\text{as : } \vec{k}_{2\omega} = \vec{k}_{\omega}^o + \vec{k}_{\omega}^e$$

The two fundamental photons have orthogonal polarizations :

QC.1 : Explain how to achieve type II phase matching with one single linearly polarized fundamental laser

QC.2 : The KDP is a negative uniaxial crystal, show that the type II phase matching condition is given by: $n_{e,2\omega}(\Theta) = \frac{1}{2}[n_{o,\omega} + n_{e,\omega}(\Theta)]$.

You could use the same method as previously in order to get angle Θ . Do not do it again during the session. We get a theoretical value : $\Theta_i = 59^\circ$.

QC.3 : In presence of a phase mismatch, the optical power of the frequency doubled beam follows a sinc^2 behavior with respect to the phase mismatch Δk :

$$\frac{P_{2\omega}}{P_{\omega}} \propto P_{\omega} \ell^2 \chi_{\text{eff}}^2 \left(\frac{\sin \frac{\Delta k \ell}{2}}{\frac{\Delta k \ell}{2}} \right)^2$$

Give an expression of Δk as a function of the optical indices when close to the type II phase matching condition.

Use fig 5 to show that the angular acceptance is better in type II phase-matching than with type I phase-matching.

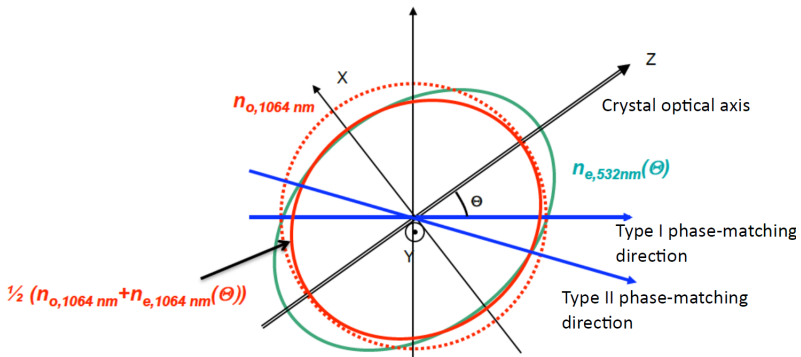

Figure 5 : Index surfaces in the KDP in the (horizontal) incidence plane.
Type II phase-matching compared to type I phase-matching

Experimental study of Type II phase matching :

To find the type II phase matching condition, the fundamental polarization should ideally be oriented at 45° with respect to the neutral axis of the crystal.

QD.1 : By which angle do you have to rotate the half wave plate between the optimal configuration for type I phase matching and type II phase matching ?

QD.2 : compare the shape of the green output beam for type II phase matching to the previously obtained shape for type I phase-matching : explain the differences.

QD.3 : Use an analyzer to give the polarization direction of the output beam with respect to the Oxyz axes, and compare this result to your theoretical predictions.

QD.4 : Phase matching angle measurement.

Use the same method as for type I phase matching, and give an experimental measure of the type II phase-matching angle with its associated uncertainty. Check if this result is valid according to your theoretical predictions

QD.5 : influence of the azimuth angle Φ .

For type II phase-matching, we can show (see Appendice) that the non-linear polarization of interest can be expressed as :

$$P_x^{NL}(2\omega) = \epsilon_0 (d'_{14} + d'_{36}) E_x(\omega) E_y(\omega) \sin(2\Theta) \cos(2\Phi)$$

Use the powermeter to measure the optical power of the frequency doubled beam as a function of the angle Φ . Plot this power as a function of Φ , and comment your observations. Superimpose both plots for type I and type II phase-matching to comment on the differences between both situations.

QD.6 : Influence of the incident polarization.

α is the angle between the fundamental laser polarization direction and the reference Oy direction.

Use the powermeter and plot $P_{2\omega} = f(\alpha)$. Comment and superimpose both plots for type I and type II phase-matching to comment on the differences between both situations.

QD.7 : Comparing the powers for type I and type II phase-matching.

Give the maximal output power for the green beams for both type I and type II phase-matching. Comment on the differences predicted by the theoretical considerations in the appendices (you can use the ratio of output optical powers between type I and type II phase-matching).

Appendice

1) Type I non-linearity

The observed non-linear process is related to a second order induced non-linear polarization. In order to understand more precisely the influence of angles θ , α et Φ on this non-linear polarization, one needs to study the second order non-linear susceptibility tensor, $\chi^{(2)}$.

We recall that the induced linear polarization can be written as :

$$\vec{P}(\omega) = \epsilon_0 \chi^{(1)}(\omega) \vec{E}(\omega)$$

For high power densities, second order, third order and higher order terms can add to the linear polarization term. For second harmonic generation, the term is related to the second order non-linear polarization :

$$P_i^{NL}(2\omega) = \epsilon_0 \sum_{j,k} \chi_{i,j,k}^{(2)} E_j(\omega) E_k(\omega)$$

where i,j,k correspond to the crystal axes X,Y,Z.

The second order non-linear susceptibility, is a tensor of rank 3 with $3^3=27$ components. For low absorption regimes and far from resonances, the tensor can be simplified with only 18 components remaining.

Moreover, when the Kleinman symmetry condition is fulfilled, (or for the specific case of SHG), the second order susceptibility tensor can be reduced to a contracted expression, by using the d_{ij} coefficients :

:

$$d_{ijk} = \frac{1}{2} \chi_{ijk}^{(2)} = d_{il}$$

The last two indices E_k can be reduced to one single index using the following rule :

Axes du cristal	XX	YY	ZZ	YZ ou ZY	XY ou YX	XY ou YX
<i>jk</i>	11	22	33	23 ou 32	13 ou 31	12 ou 21
<i>l</i>	1	2	3	4	5	6

The tensor can then be expressed as a 6x3 matrix, containing 18 elements :

$$d_{il} = \begin{bmatrix} d_{11} & d_{12} & d_{13} & d_{14} & d_{15} & d_{16} \\ d_{21} & d_{22} & d_{23} & d_{24} & d_{25} & d_{26} \\ d_{31} & d_{32} & d_{33} & d_{34} & d_{35} & d_{36} \end{bmatrix}$$

The KDP crystal under study in this labwork session belongs to the tetragonal symmetry group $\bar{4}2m$. The contracted susceptibility tensor has only 3 non-zero elements remaining :

$$d_{il} = \begin{bmatrix} 0 & 0 & 0 & d_{14} & 0 & 0 \\ 0 & 0 & 0 & 0 & d_{25} & 0 \\ 0 & 0 & 0 & 0 & 0 & d_{36} \end{bmatrix}$$

With $d_{14} = d_{25}$, and $d_{14} = 0,39 \text{ pm.V}^{-1}$ and $d_{36} = 0,43 \text{ pm.V}^{-1}$.

In the crystal axis frame (O, X, Y, Z) :

$$P_i^{NL}(2\omega) = \epsilon_0 \sum_{j,k} \chi_{i,j,k}^{(2)} E_j(\omega) E_k(\omega)$$

Is given by :

$$\begin{pmatrix} P_X(2\omega) \\ P_Y(2\omega) \\ P_Z(2\omega) \end{pmatrix} = 2\epsilon_0 \begin{pmatrix} 0 & 0 & 0 & d_{14} & 0 & 0 \\ 0 & 0 & 0 & 0 & d_{14} & 0 \\ 0 & 0 & 0 & 0 & 0 & d_{36} \end{pmatrix} \begin{pmatrix} E_X^2(\omega) \\ E_Y^2(\omega) \\ E_Z^2(\omega) \\ 2E_Y(\omega)E_Z(\omega) \\ 2E_X(\omega)E_Z(\omega) \\ 2E_X(\omega)E_Y(\omega) \end{pmatrix}$$

$$\text{so : } P_i^{NL}(2\omega) = \varepsilon_0 \sum_{j,k} \chi_{i,j,k}^{(2)} E_j(\omega) E_k(\omega)$$

$$\begin{pmatrix} P_X(2\omega) \\ P_Y(2\omega) \\ P_Z(2\omega) \end{pmatrix} = 4\varepsilon_0 \begin{pmatrix} d_{14} E_Y(\omega) E_Z(\omega) \\ d_{14} E_X(\omega) E_Z(\omega) \\ d_{36} E_X(\omega) E_Y(\omega) \end{pmatrix}$$

For a type I phase-matching in KDP, the incident wave is necessarily ordinary polarized, meaning its projection on the optical axis OZ is zero. There is only one term contributing to the frequency doubled beam :

$$P_Z^{NL}(2\omega) = \varepsilon_0 \chi_{Z,X,Y}^{(2)} E_X(\omega) E_Y(\omega) + \varepsilon_0 \chi_{Z,Y,X}^{(2)} E_X(\omega) E_Y(\omega)$$

$$P_Z^{NL}(2\omega) = 2\varepsilon_0 \chi_{Z,X,Y}^{(2)} E_X(\omega) E_Y(\omega) = 4\varepsilon_0 d_{36} E_X(\omega) E_Y(\omega)$$

Moreover, In this configuration, the output beam is extraordinary polarized. The induced non-linear polarization must then be projected onto the direction (Ox).

We get :
$$P_x^{NL}(2\omega) = \varepsilon_0 \chi_{eff}^{(2)} E_y^2(\omega) \quad \text{with}$$

$\chi_{\theta\theta,\theta}^{(2)}(2\omega, \omega, \omega) = 2d_{36} \sin(\Theta) \sin(2\Phi)$, the effective non-linear permittivity in type I phase-matching

2) Type II non-linearity

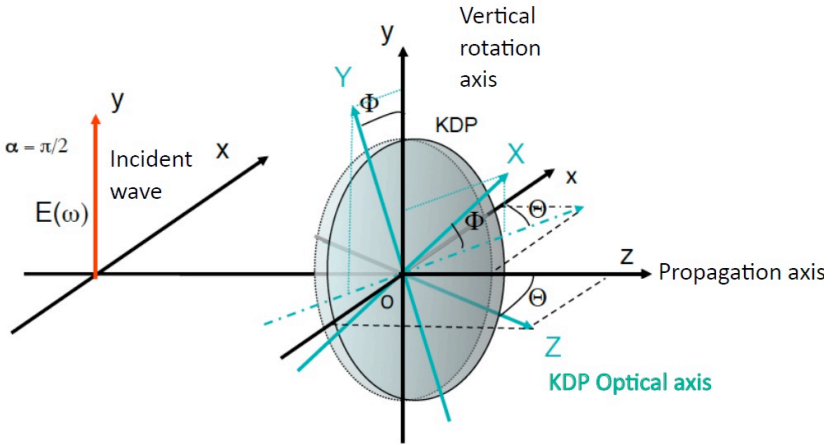

In the crystal axes frame (O,X,Y,Z), the non-linear polarization writes :

$$P_i^{NL}(2\omega) = \varepsilon_0 \sum_{j,k} \chi_{i,j,k}^{(2)} E_j(\omega) E_k(\omega)$$

So :

$$\begin{pmatrix} P_X(2\omega) \\ P_Y(2\omega) \\ P_Z(2\omega) \end{pmatrix} = 2\varepsilon_0 \begin{pmatrix} 0 & 0 & 0 & d_{14} & 0 & 0 \\ 0 & 0 & 0 & 0 & d_{14} & 0 \\ 0 & 0 & 0 & 0 & 0 & d_{36} \end{pmatrix} \begin{pmatrix} E_X^2(\omega) \\ E_Y^2(\omega) \\ E_Z^2(\omega) \\ 2E_Y(\omega)E_Z(\omega) \\ 2E_X(\omega)E_Z(\omega) \\ 2E_X(\omega)E_Y(\omega) \end{pmatrix}$$

$$\begin{pmatrix} P_X(2\omega) \\ P_Y(2\omega) \\ P_Z(2\omega) \end{pmatrix} = 4\varepsilon_0 \begin{pmatrix} d_{14} E_Y(\omega) E_Z(\omega) \\ d_{14} E_X(\omega) E_Z(\omega) \\ d_{36} E_X(\omega) E_Y(\omega) \end{pmatrix}$$

In type II phase-matching, the incident wave has two components : the ordinary component along (Oy) and the extraordinary component along (Ox). The output beam is an extraordinary wave (polarized along Ox). First, one has to write the components of the incident wave in the crystal axes frame, and then project the polarization on the Ox direction.

E_x, E_y, E_z can be written as functions of de E_x, E_y, E_z :

$$E_X = E_x \cos(\Theta) \cos(\Phi) + E_y \sin(\Phi) + E_z \cos(\Phi) \sin(\Theta)$$

$$E_Y = -E_x \cos(\Theta) \sin(\Phi) + E_y \cos(\Phi) - E_z \sin(\Phi) \sin(\Theta)$$

$$E_Z = -E_x \sin(\Theta) + E_z \cos(\Theta)$$

$E_z = 0$ then :

$$E_X = E_x \cos(\Theta) \cos(\Phi) + E_y \sin(\Phi)$$

$$E_Y = -E_x \cos(\Theta) \sin(\Phi) + E_y \cos(\Phi)$$

$$E_Z = -E_x \sin(\Theta)$$

$$\begin{pmatrix} P_x(2\omega) \\ P_y(2\omega) \\ P_z(2\omega) \end{pmatrix} = 4\varepsilon_0 \begin{pmatrix} d_{14}E_y(\omega)E_z(\omega) \\ d_{14}E_x(\omega)E_z(\omega) \\ d_{36}E_x(\omega)E_y(\omega) \end{pmatrix}$$

$$= 2\varepsilon_0 \begin{pmatrix} d_{14}E_xE_x \sin(2\Theta)\sin(\Phi) - d_{14}E_xE_y \sin(\Theta)\cos(\Phi) \\ -d_{14}E_xE_x \sin(2\Theta)\cos(\Phi) - d_{14}E_xE_y \sin(\Theta)\sin(\Phi) \\ -d_{36}E_xE_x \cos^2(\Theta)\sin(2\Phi) + d_{36}E_yE_y \sin(2\Phi) + d_{36}E_xE_y \cos(\Theta)\cos(2\Phi) \end{pmatrix}$$

We know that E_x is an ordinary wave and E_y is an extraordinary wave, so the terms $E_xE_x = E_yE_y$ do not contribute efficiently to the SHG process for a type II phase-matching. The remaining contributions are :

$$\begin{pmatrix} P_x(2\omega) \\ P_y(2\omega) \\ P_z(2\omega) \end{pmatrix} = 4\varepsilon_0 \begin{pmatrix} d_{14}E_y(\omega)E_z(\omega) \\ d_{14}E_x(\omega)E_z(\omega) \\ d_{36}E_x(\omega)E_y(\omega) \end{pmatrix} = 2\varepsilon_0 \begin{pmatrix} -d_{14}E_xE_y \sin(\Theta)\cos(\Phi) \\ -d_{14}E_xE_y \sin(\Theta)\sin(\Phi) \\ d_{36}E_xE_y \cos(\Theta)\cos(2\Phi) \end{pmatrix}$$

Finally, one has to project those components onto the direction Ox .

$$P_x = P_x \cos(\Theta)\cos(\Phi) - P_y \cos(\Theta)\sin(\Phi) - P_z \sin(\Theta)$$

$$\text{We get : } P_x(2\omega) = \varepsilon_0(d_{14} + d_{36})E_x(\omega)E_y(\omega)\sin(2\Theta)\cos(2\Phi)$$