

Ingénierie Electronique pour le Traitement de l'Information

TD5 – S6

Corriger un « vrai » système

Julien VILLEMEJANE



Paris-Saclay



Saint-Étienne



Bordeaux

• Asservissement de la position d'un faisceau LASER

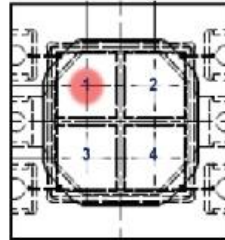
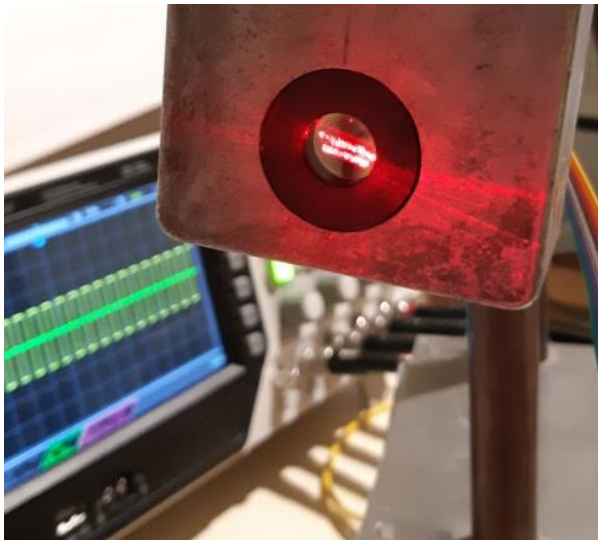
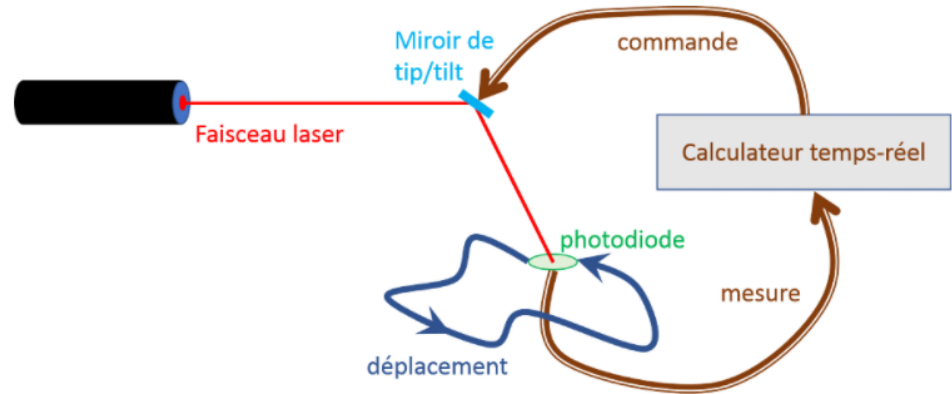

Paris-Saclay



Saint-Étienne



Bordeaux

• Asservissement de la position d'un faisceau LASER

$$T(p) = \frac{G_0}{1 + \frac{2 \cdot m \cdot p}{w_c} + \frac{p^2}{w_c^2}}$$

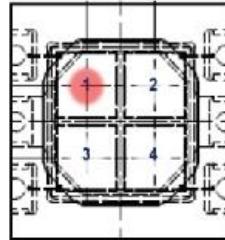
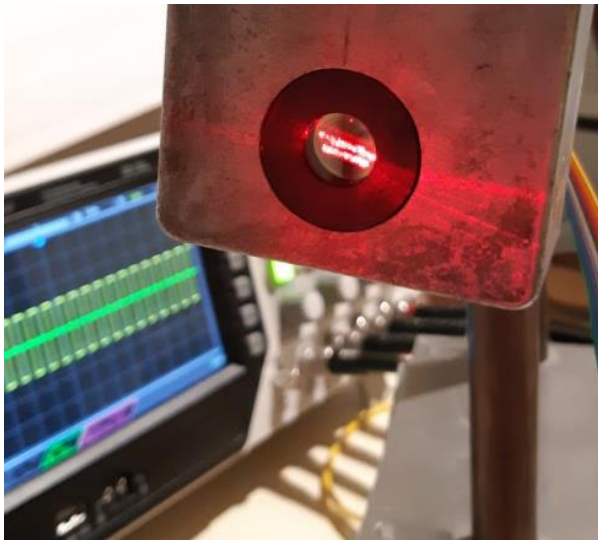
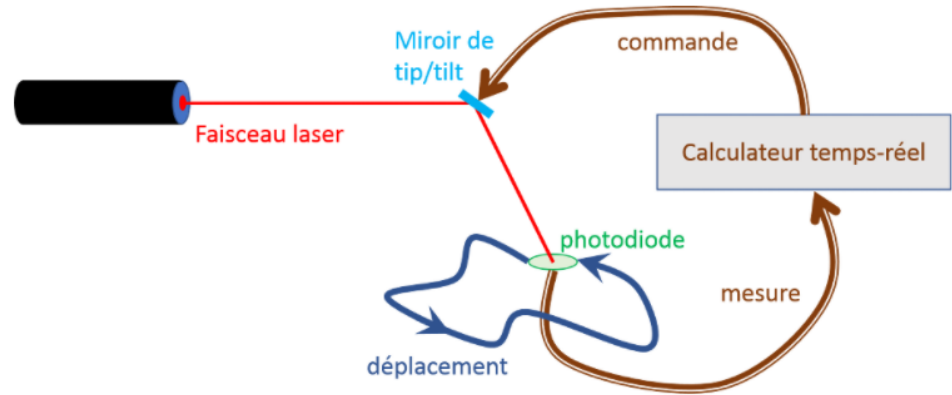

$$K_{capt} = 10$$



Paris-Saclay



Saint-Étienne



Bordeaux

• Asservissement de la position d'un faisceau LASER

$$T(p) = \frac{G_0}{1 + \frac{2 \cdot m \cdot p}{w_c} + \frac{p^2}{w_c^2}}$$

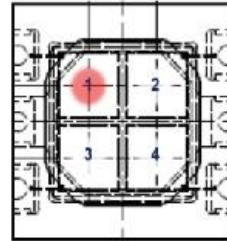
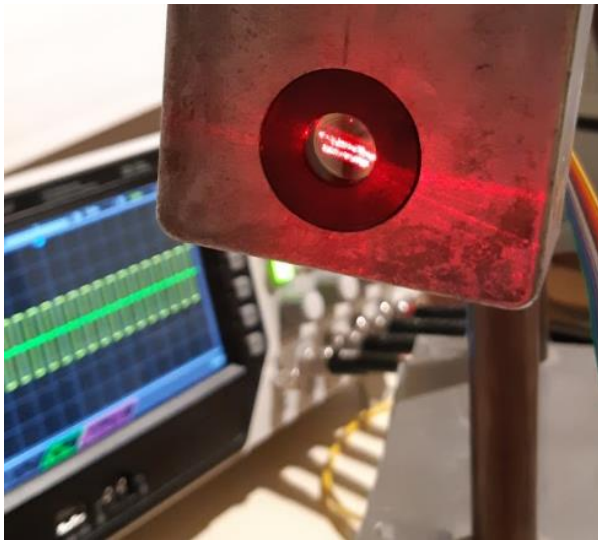
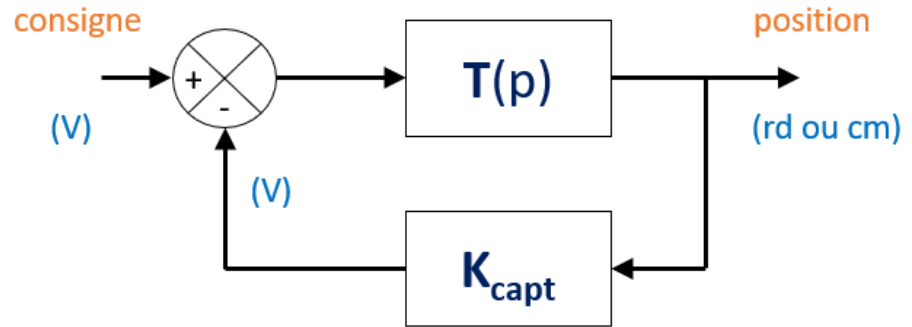

$$K_{capt} = 10$$



Paris-Saclay



Saint-Étienne



Bordeaux

- Exercice 1 / Réponse à un échelon

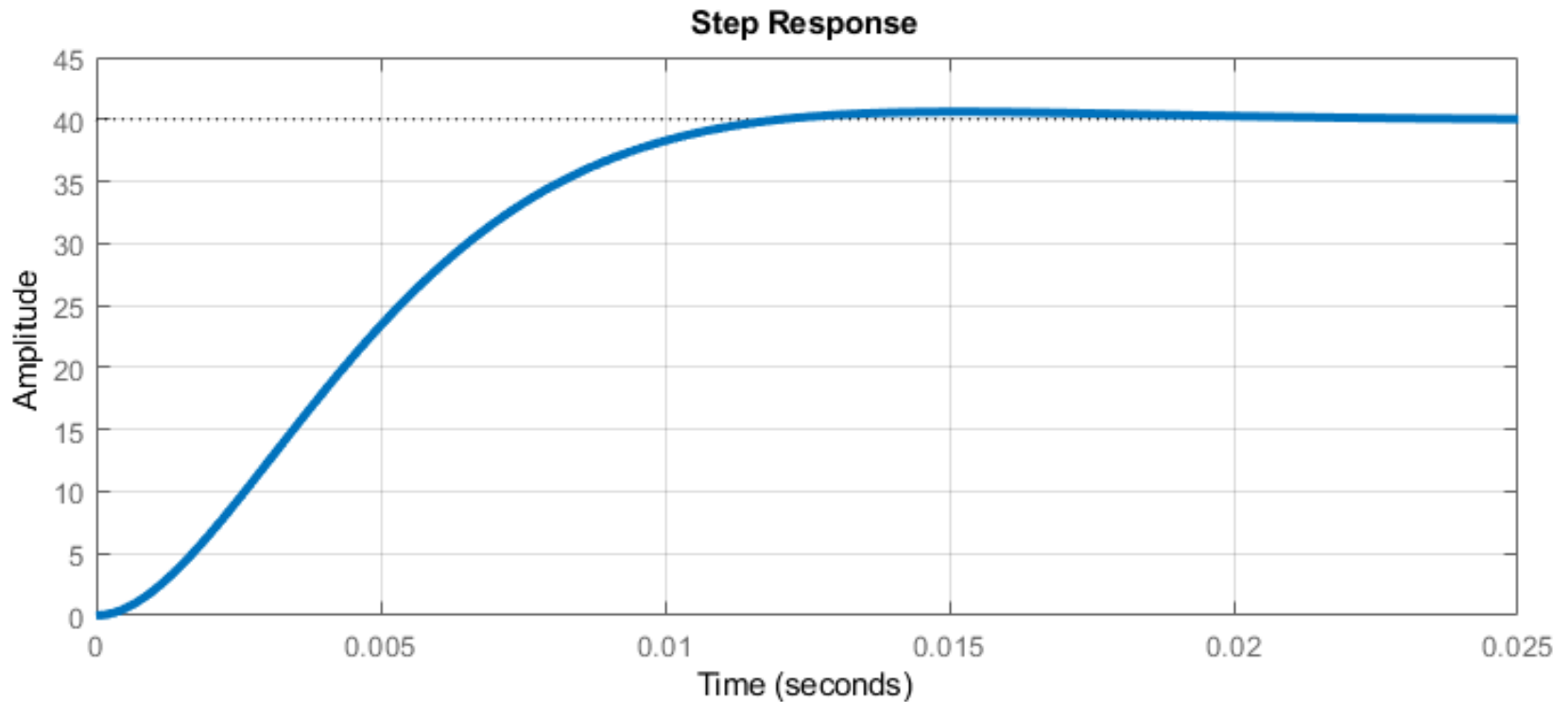

- Exercice 1 / Diagramme de Bode

$G_0 = 40$
 $f_c = 55 \text{ Hz}$
 $m = 0.8$

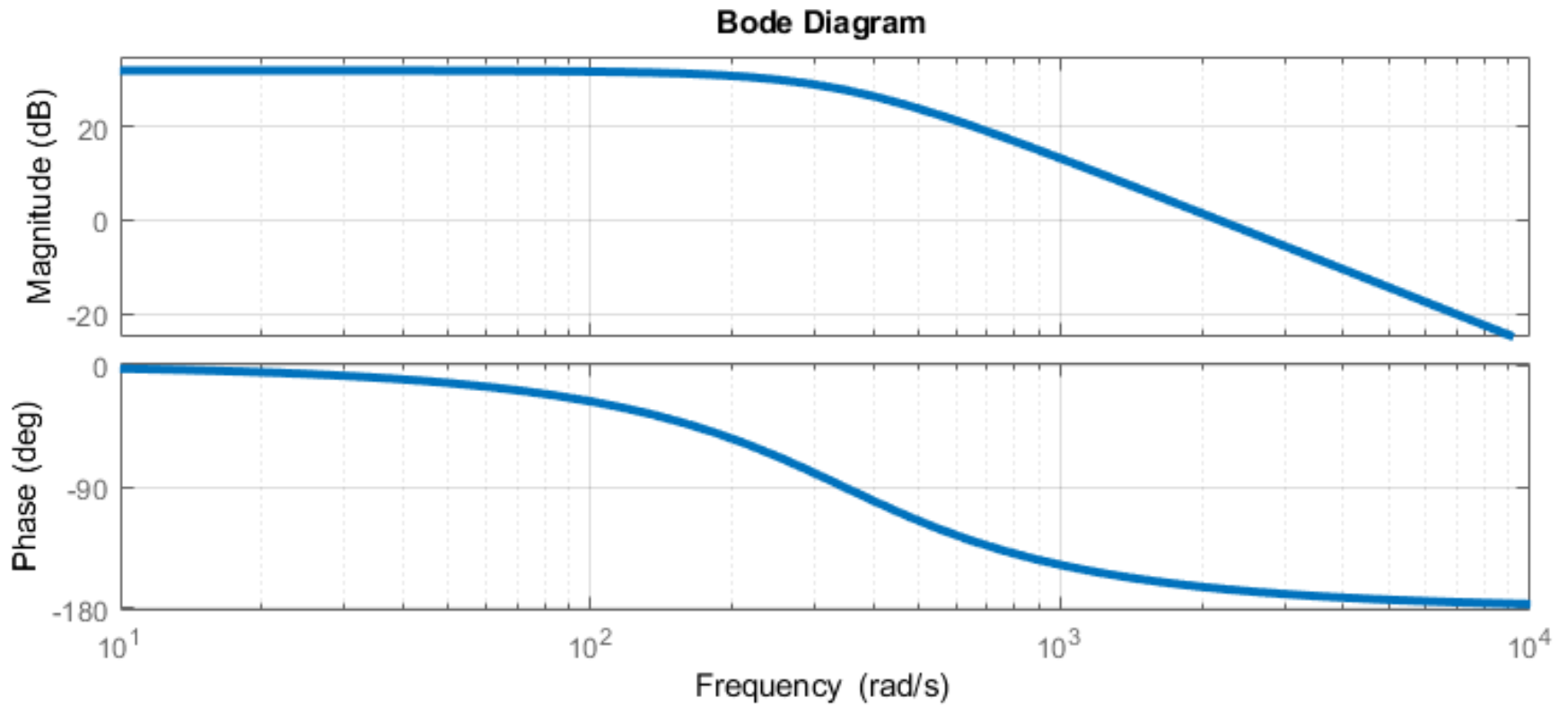

- Exercice 2 / Système asservi

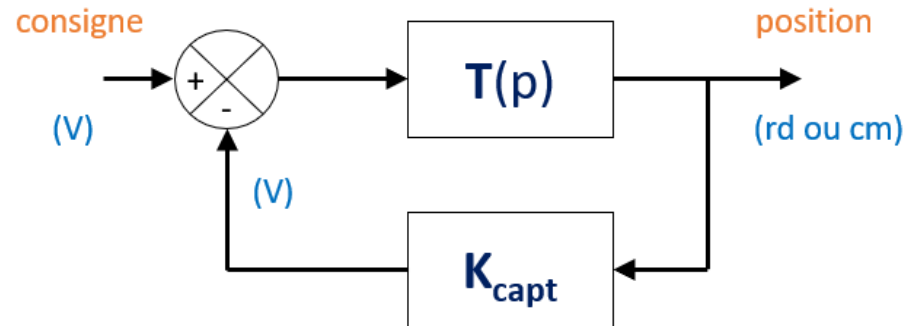

• Exercice 2 / Système asservi

$$T_{BF}(p) = \frac{T(p)}{1 + T(p) \cdot K_{capt}}$$

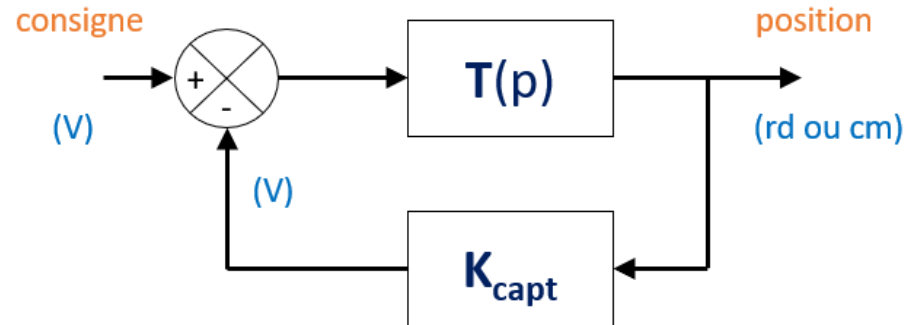

• Exercice 2 / Système asservi

$$T_{BF}(p) = \frac{T(p)}{1 + T(p) \cdot K_{capt}}$$

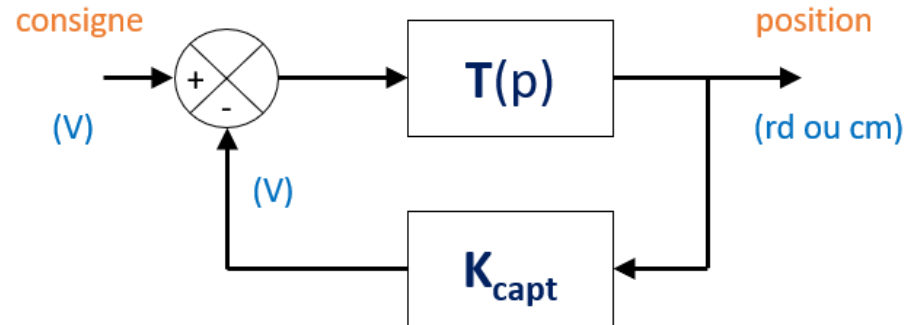

$$T_{BF}(p) = \frac{G_0}{1 + G_0 \cdot K_{capt}} \cdot \frac{1}{1 + \frac{2 \cdot m \cdot p}{\omega_c \cdot (1 + G_0 \cdot K_{capt})} + \frac{p^2}{\omega_c^2 \cdot (1 + G_0 \cdot K_{capt})}}$$



Paris-Saclay



Saint-Étienne



Bordeaux

• Exercice 2 / Système asservi

$$T_{BF}(p) = \frac{T(p)}{1 + T(p) \cdot K_{capt}}$$

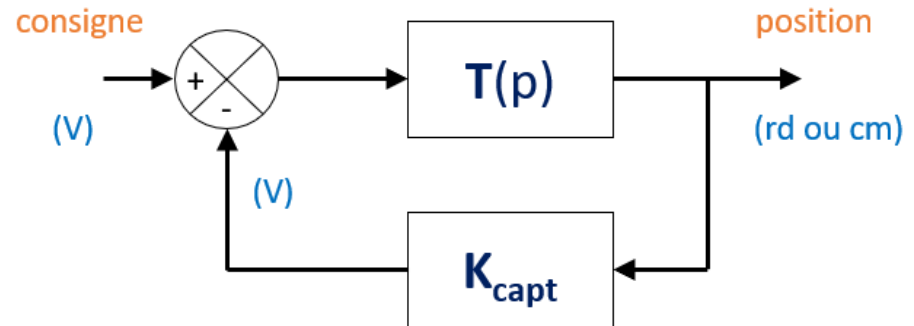

$$T_{BF}(p) = \frac{G_0}{1 + G_0 \cdot K_{capt}} \cdot \frac{1}{1 + \frac{2 \cdot m \cdot p}{\omega_c \cdot (1 + G_0 \cdot K_{capt})} + \frac{p^2}{\omega_c^2 \cdot (1 + G_0 \cdot K_{capt})}}$$

G_{0BF}

m_{BF}

ω_{CBF}

0.0998

0.04

1100 Hz



Paris-Saclay



Saint-Étienne



Bordeaux

• Exercice 2 / Système asservi

$$T_{BF}(p) = \frac{T(p)}{1 + T(p) \cdot K_{capt}}$$



$$G_{0BF} = \frac{G_0}{1 + G_0 \cdot K_{capt}} = 0.0998$$

$$f_{cBF} = f_c \cdot \sqrt{1 + G_0 \cdot K_{capt}} = 1100 \text{ Hz}$$

$$m_{BF} = \frac{m}{\sqrt{1 + G_0 \cdot K_{capt}}} = 0.04$$

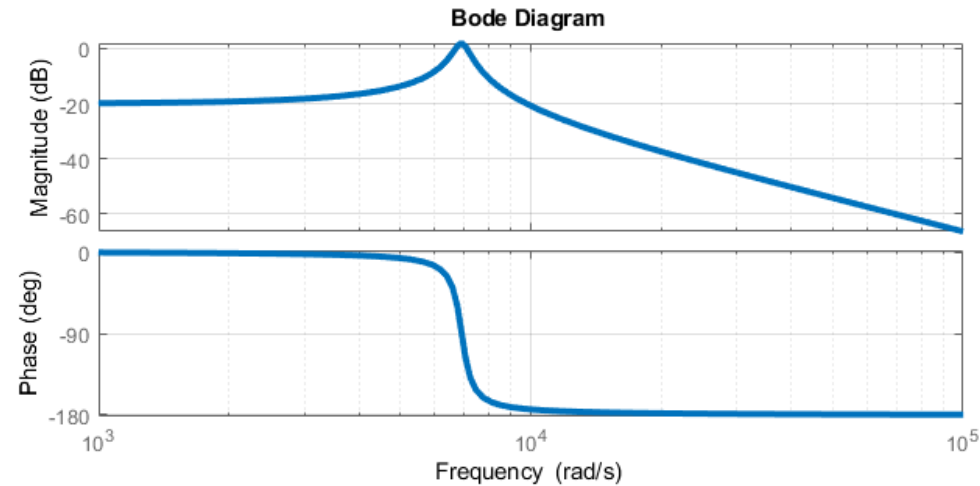
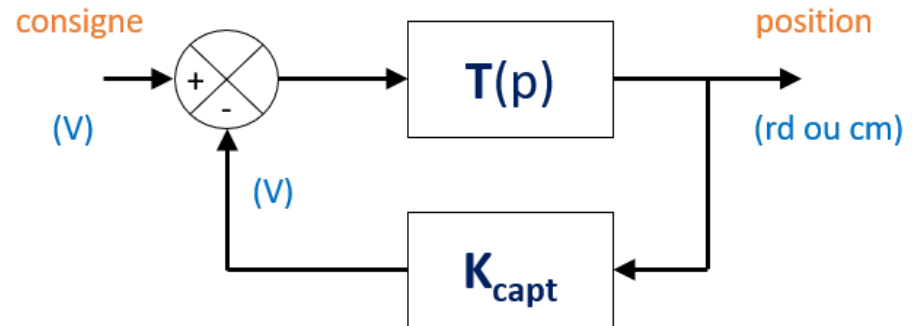

Paris-Saclay



Saint-Étienne



Bordeaux

- Exercice 2 / Système asservi

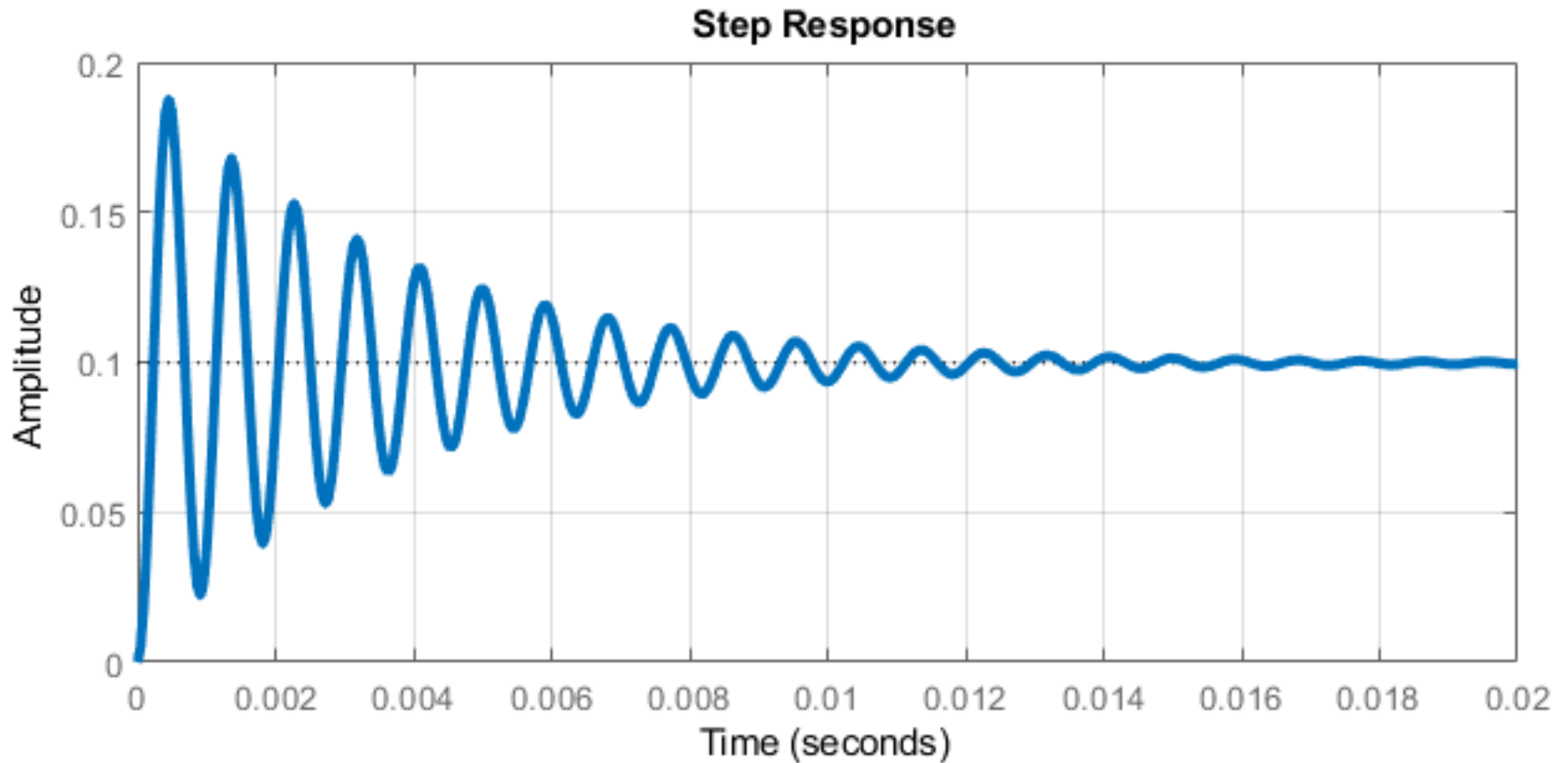

Paris-Saclay



Saint-Étienne



Bordeaux

• Exercice 3 / Système corrigé

Proportionnel Intégral Dérivé (PID)

$$C(p) = K \cdot \left(1 + \frac{1}{K_i \cdot p} + K_d \cdot p \right)$$

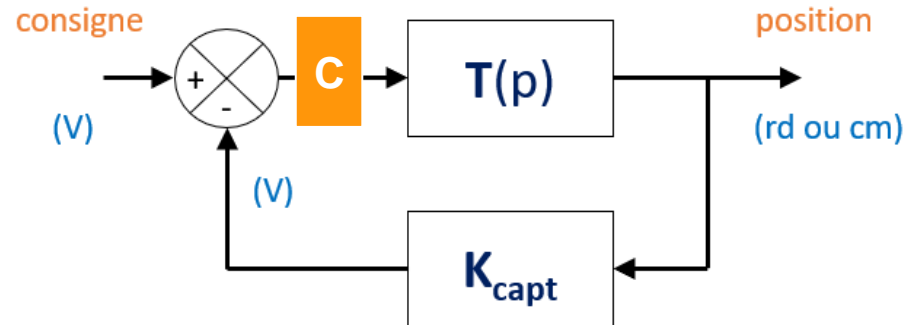

• Exercice 3 / Système corrigé

Proportionnel Intégral Dérivé (PID)

$$C(p) = K \cdot \left(1 + \frac{1}{K_i \cdot p} + K_d \cdot p \right)$$

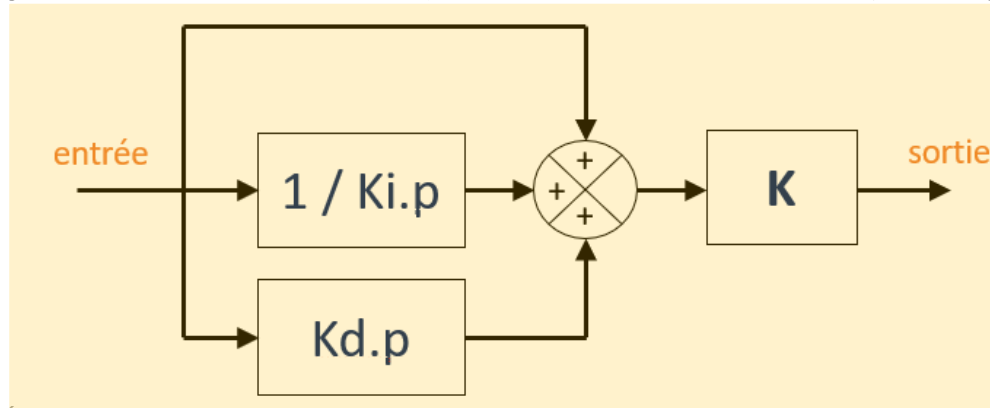
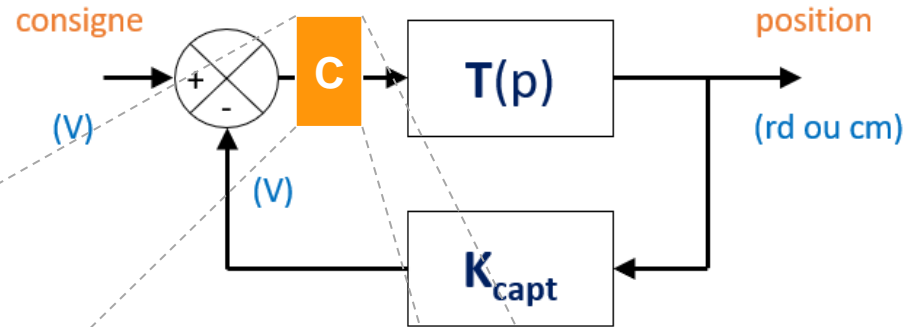

Paris-Saclay



Saint-Étienne



Bordeaux

• Exercice 3 / Système corrigé

Proportionnel Intégral Dérivé (PID)

$$C(p) = K \cdot \left(1 + \frac{1}{K_i \cdot p} + K_d \cdot p \right)$$

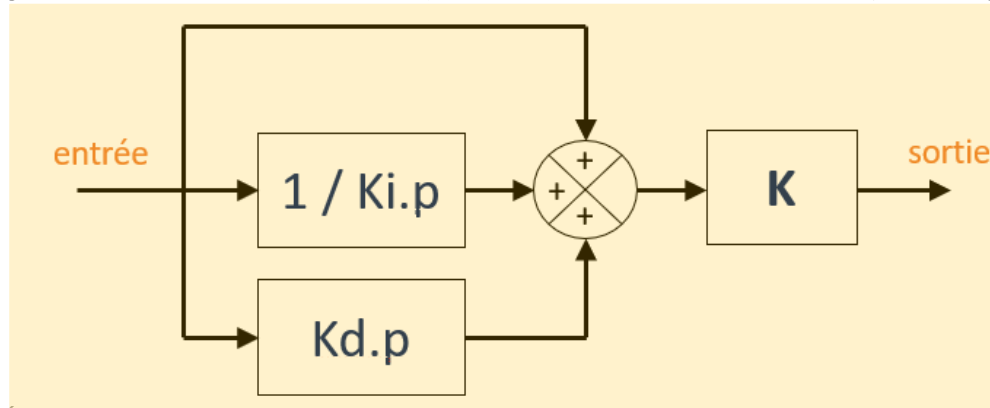
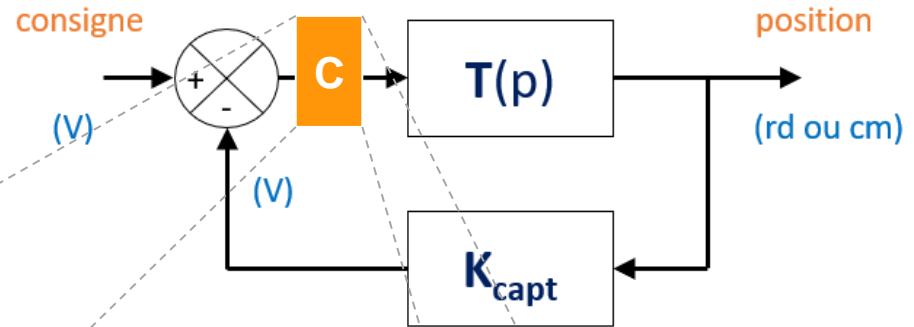

• Exercice 3 / Système corrigé

Proportionnel Intégral Dérivé (PID)

$$C(p) = K \cdot \left(1 + \frac{1}{K_i \cdot p} + K_d \cdot p \right)$$

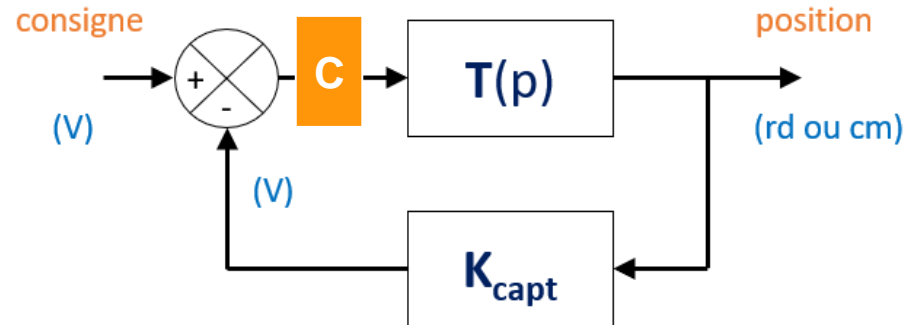

• Exercice 3 / Système corrigé

Proportionnel Intégral Dérivé (PID)

$$C(p) = K \cdot \left(1 + \frac{1}{K_i \cdot p} + K_d \cdot p \right)$$



$$T_{BF}(p) = \frac{K \cdot T(p)}{1 + K \cdot T(p) \cdot K_{capt}}$$

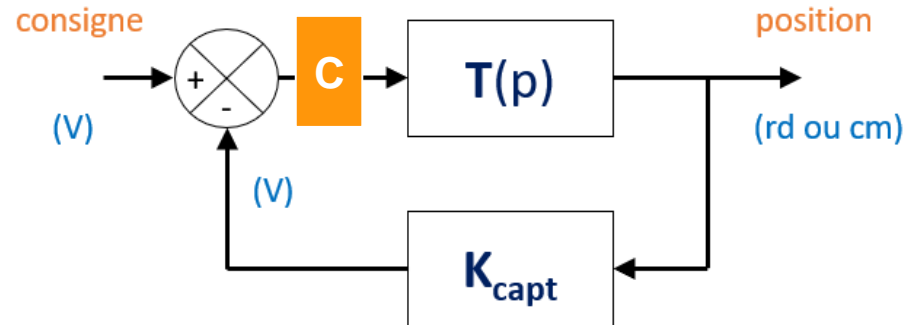

• Exercice 3 / Système corrigé

Proportionnel Intégral Dérivé (PID)

$$C(p) = K \cdot \left(1 + \frac{1}{K_i \cdot p} + K_d \cdot p \right)$$

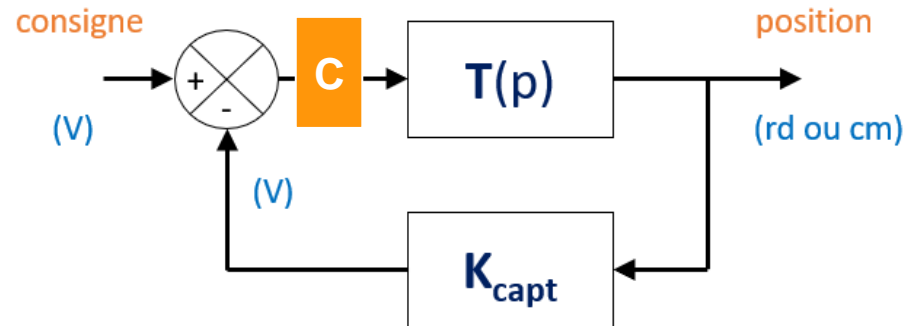

$$T_{BF}(p) = \frac{K \cdot T(p)}{1 + K \cdot T(p) \cdot K_{capt}}$$



$$T_{BF}(p) = \frac{K \cdot G_0}{1 + K \cdot G_0 \cdot K_{capt}} \cdot \frac{1}{1 + \frac{2 \cdot m \cdot p}{\omega_c \cdot (1 + G_0 \cdot K \cdot K_{capt})} + \frac{p^2}{\omega_c^2 \cdot (1 + G_0 \cdot K \cdot K_{capt})}}$$



Paris-Saclay



Saint-Étienne



Bordeaux

• Exercice 3 / Système corrigé

Proportionnel Intégral Dérivé (PID)

$$C(p) = K \cdot \left(1 + \frac{1}{K_i \cdot p} + K_d \cdot p \right)$$



$$T_{BF}(p) = \frac{K \cdot T(p)}{1 + K \cdot T(p) \cdot K_{capt}}$$

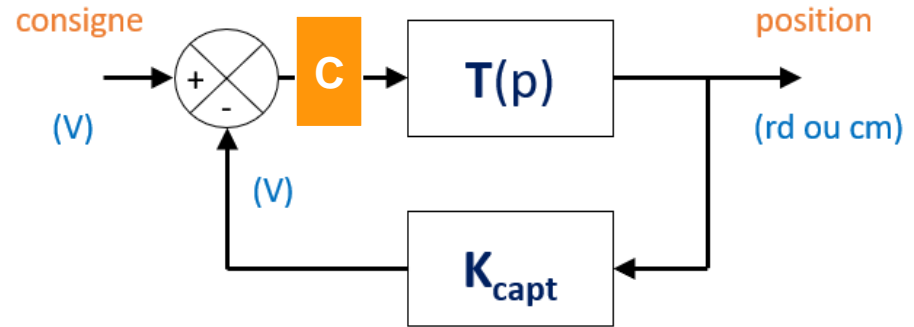

$$G_{0BF} = \frac{K \cdot G_0}{1 + K \cdot G_0 \cdot K_{capt}}$$

$$f_{cBF} = f_c \cdot \sqrt{1 + G_0 \cdot K \cdot K_{capt}}$$

$$m_{BF} = \frac{m}{\sqrt{1 + G_0 \cdot K \cdot K_{capt}}}$$



Paris-Saclay



Saint-Étienne



Bordeaux

• Exercice 3 / Système corrigé

Proportionnel Intégral Dérivé (PID)

$$C(p) = K \cdot \left(1 + \frac{1}{K_i \cdot p} + K_d \cdot p \right)$$



$$K = 10$$

$$G_{0BF} = \frac{K \cdot G_0}{1 + K \cdot G_0 \cdot K_{capt}} = 0.1$$

$$f_{cBF} = f_c \cdot \sqrt{1 + G_0 \cdot K \cdot K_{capt}} = 3.48 \text{ kHz}$$

$$m_{BF} = \frac{m}{\sqrt{1 + G_0 \cdot K \cdot K_{capt}}} = 0.0126$$

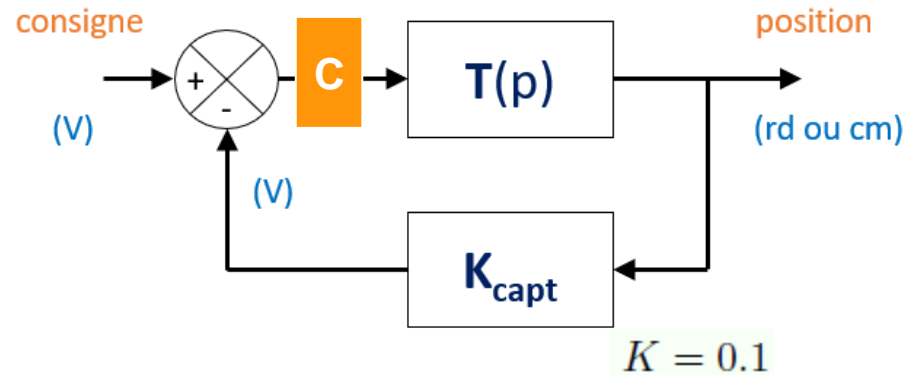

$$G_{0BF} = \frac{K \cdot G_0}{1 + K \cdot G_0 \cdot K_{capt}} = 0.0976$$

$$f_{cBF} = f_c \cdot \sqrt{1 + G_0 \cdot K \cdot K_{capt}} = 352 \text{ kHz}$$

$$m_{BF} = \frac{m}{\sqrt{1 + G_0 \cdot K \cdot K_{capt}}} = 0.125$$



Paris-Saclay



Saint-Étienne



Bordeaux

• Exercice 3 / Système corrigé

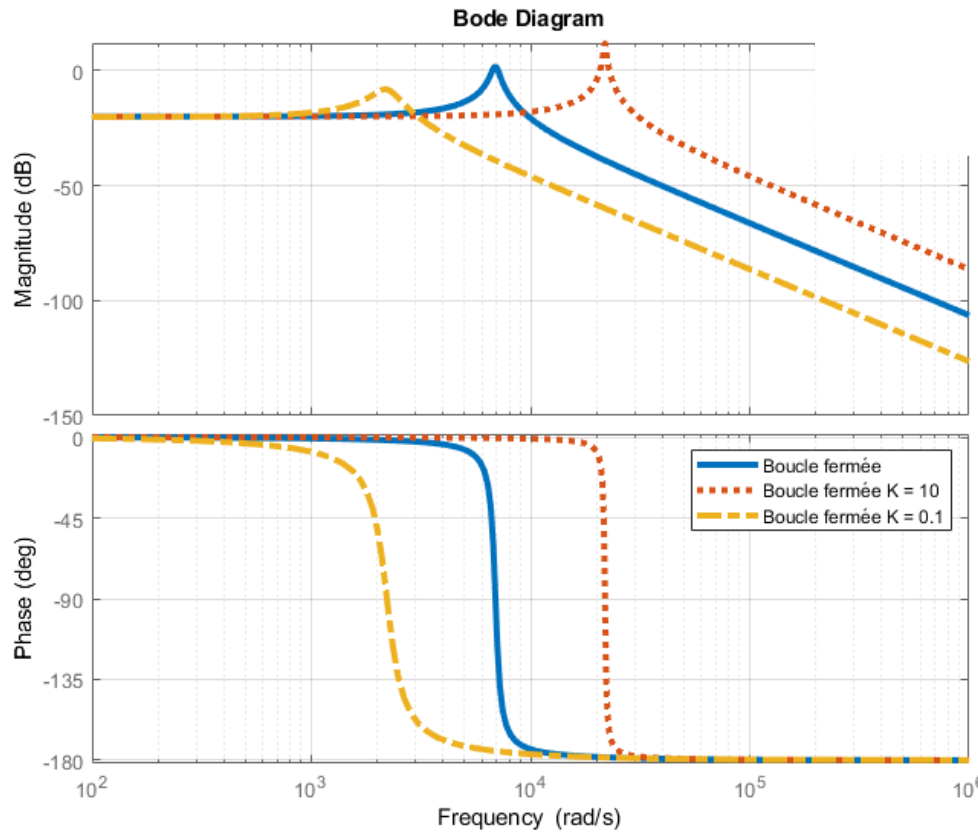
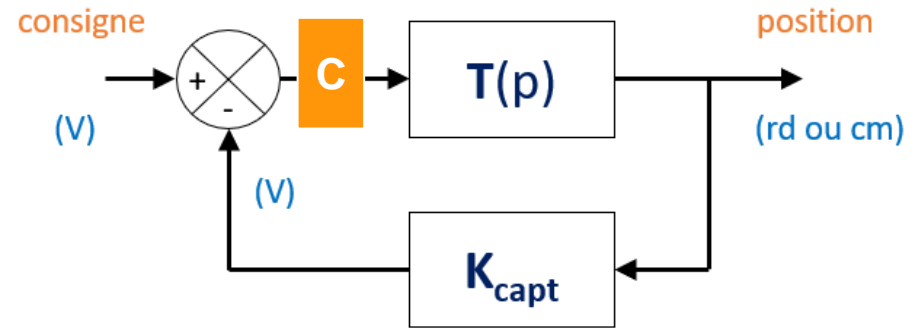

Proportionnel Intégral Dérivé (PID)

$$C(p) = K \cdot \left(1 + \frac{1}{K_i \cdot p} + K_d \cdot p \right)$$



Paris-Saclay



Saint-Étienne



Bordeaux

• Exercice 3 / Système corrigé

Proportionnel Intégral Dérivé (PID)

$$C(p) = K \cdot \left(1 + \frac{1}{K_i \cdot p} + K_d \cdot p \right)$$

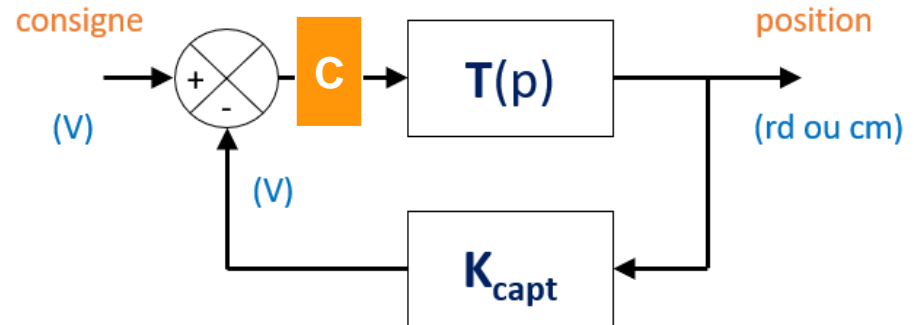

• Exercice 3 / Système corrigé

Proportionnel Intégral Dérivé (PID)

$$C(p) = K \cdot \left(1 + \frac{1}{K_i \cdot p} + K_d \cdot p \right)$$



$$T_{BF}(p) = \frac{C(p) \cdot T(p)}{1 + K_{capt} \cdot C(p) \cdot T(p)}$$

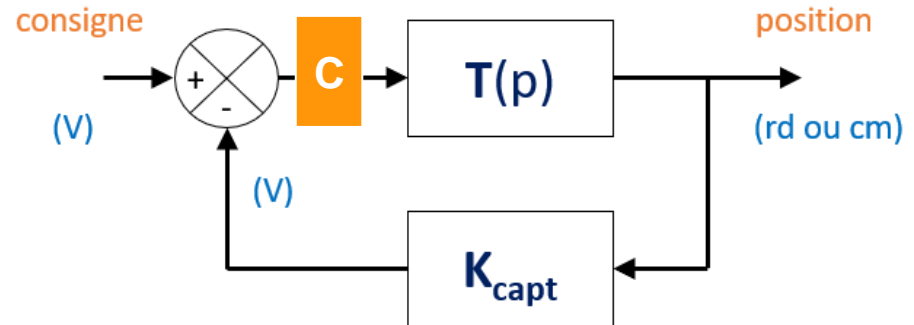

• Exercice 3 / Système corrigé

Proportionnel Intégral Dérivé (PID)

$$C(p) = K \cdot \left(1 + \frac{1}{K_i \cdot p} + K_d \cdot p \right)$$



$$T_{BF}(p) = \frac{C(p) \cdot T(p)}{1 + K_{capt} \cdot C(p) \cdot T(p)}$$



$$M = K_{capt} \cdot K \cdot G_0$$

$$T_{BF}(p) = \frac{K \cdot G_0}{1 + M} \cdot \frac{1 + \tau_i \cdot p}{1 + \frac{p}{1+M} \cdot \left(\frac{2 \cdot m}{\omega_c} + \tau_i \cdot M \right) + \frac{p^2}{\omega_c^2 \cdot (1+M)}}$$

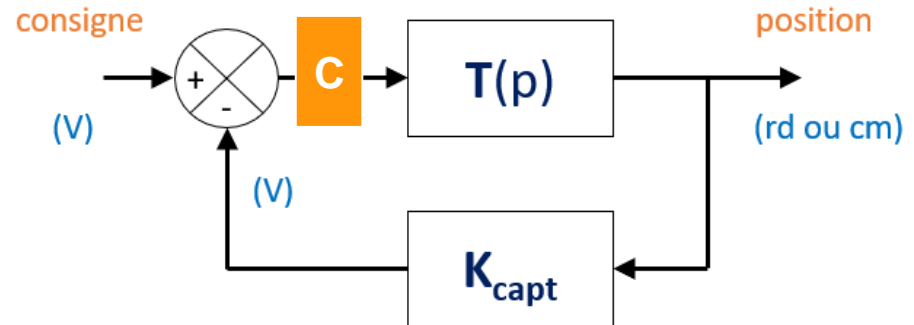

Paris-Saclay



Saint-Étienne



Bordeaux

• Exercice 3 / Système corrigé

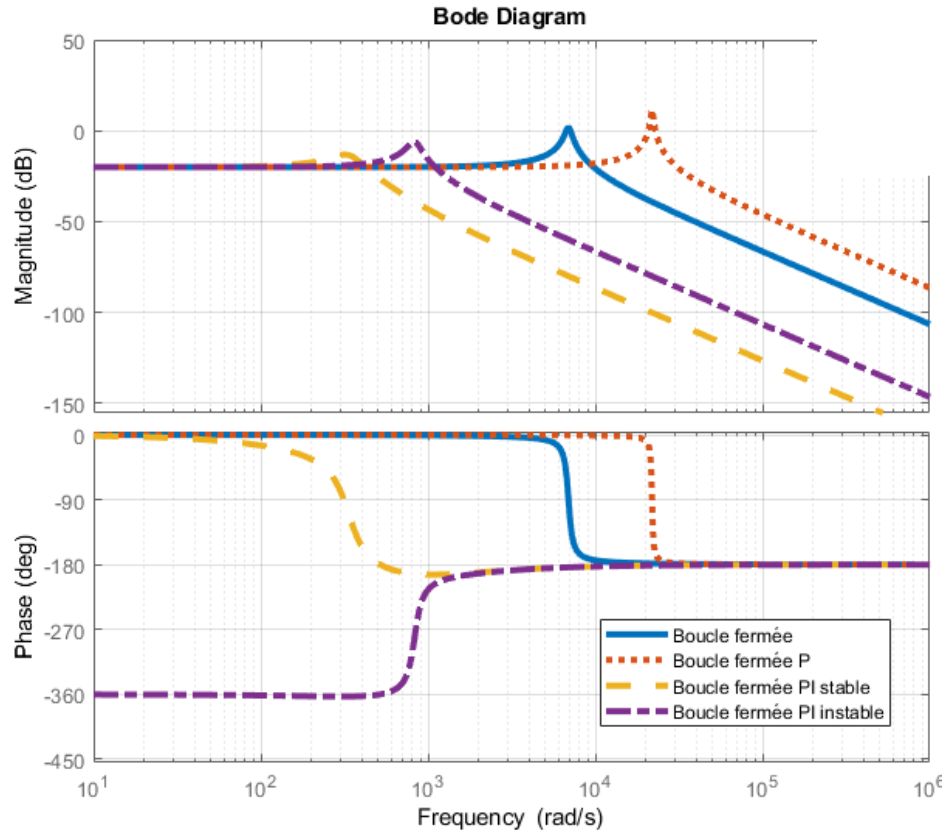
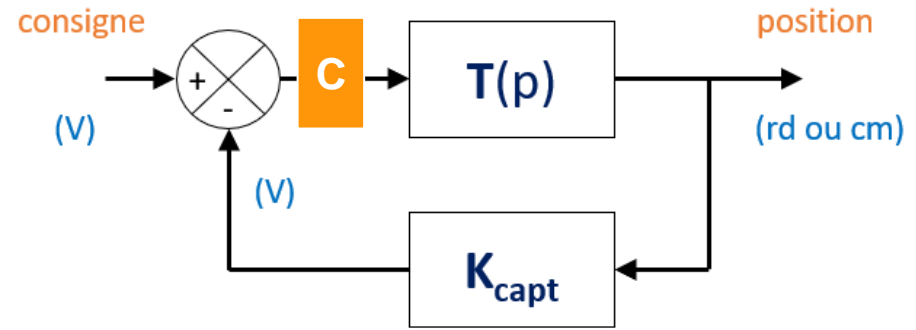

Proportionnel Intégral Dérivé (PID)

$$C(p) = K \cdot \left(1 + \frac{1}{K_i \cdot p} + K_d \cdot p \right)$$



• Exercice 3 / Système corrigé

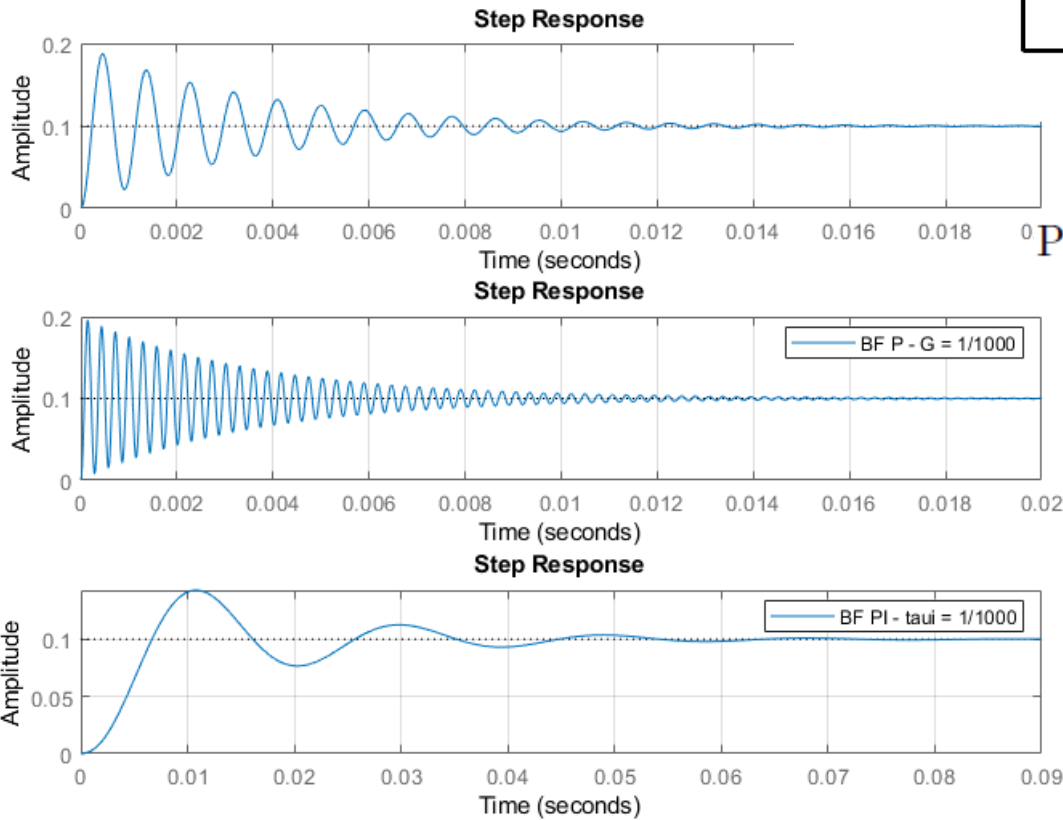
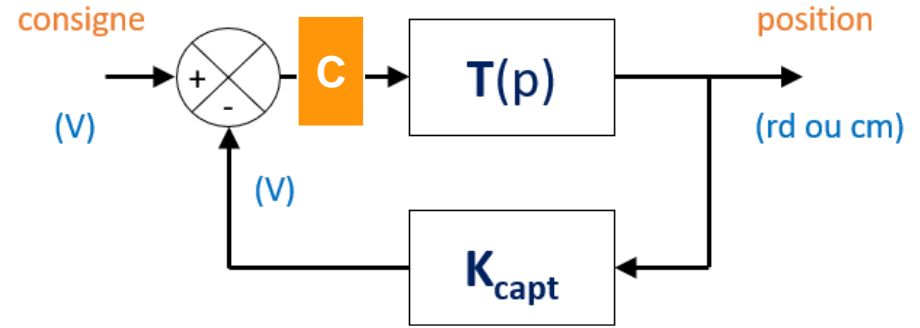

Proportionnel Intégral Dérivé (PID)

$$C(p) = K \cdot \left(1 + \frac{1}{K_i \cdot p} + K_d \cdot p \right)$$

