

Lab work in photonics

Aberrations

General presentation	1
Specification of the lenses	11
1 On-axis aberrations using the "point source method"	15
2 Off-axis aberrations using the "point source method"	27
3 ZYGO wavefront analyser	37
4 HASO wavefront analyzer	51

Rooms	A1	A2	A3	A4
	S1.10	S1.8	S1.2	S1.4

lense.institutoptique.fr | Deuxième année | Photonique S8

Engineer - 2nd year - S8 -Palaiseau
Version: January 20, 2025
Year 2024-2025

General presentation

Learning outcomes

At the end of the 4 lab sessions, students are able to:

- Implement methods of characterization of optical imaging systems. These methods include the simple star test method, as well as the use of instruments commonly found in the industry such as Zygo interferometer and Schack-Hartmann wavefront analyzer (HASO)
- Establish the suitability or limitations of an optical system with the imaging application for which it is dedicated

Contents

1	The point source method	2
2	Wavefront measurements	4

Introduction

The goal of the following lab sessions is to study and analyze the defects of an optical system, i.e. the geometrical and chromatic aberrations. The lab sessions dedicated to this study should be considered as a whole, since you will study the same optical systems by various methods and then summarize and compare the results.

Preparation

Each lab session should be prepared ahead of time: for each lab session, we expect from you that you understand the measurement methods ahead of time, and that you do the preliminary calculations for the set-up specific to this lab session. Preparatory should be answered during this preparation phase.

Report

For lab no. 1 and 2, a global report must be submitted on the eCampus site no later than one week after the last session. For lab no. 3 (Zygo), the report must be submitted no later than one week after the session. For lab no. 4 (HASO), the results sheet and a short report (of one page maximum) must be submitted on eCampus website the day after the session at noon.

In practise

You will analyze by several complementary methods: a simple plano-convex lens, a Clairaut-Mossotti type doublet, and an enlarger objective.

The point source method

Lab A1 spherical aberration and chromatism

Lab A2 off-axis aberrations

During these lab sessions, you will observe the image spot directly with a microscope viewer. Observing the image spot, i.e. the Point Spread Function of the optical system under test, allows you to evaluate the performance of the optical system rapidly on axis and off axis, in the presence of monochromatic or polychromatic light, even with large aberrations.

Analysis of the transmitted wavefront

Lab A3 Fizeau interferometer (ZYGO)

Lab A4 Shack-Hartmann analyzer (HASO)

During these lab sessions, you will study the wavefront after transmission through the optical system under test, firstly by an interferometric method (with the ZYGO), and secondly by a geometrical method (with the HASO). Both methods allow you to measure the Optical Path Delay between the transmitted wavefront and the ideal spherical wavefront, i.e. the “reference sphere”. These two methods are well suited for optical systems with small aberrations.

1 The point source method

An easy and fairly efficient way to study the quality of an optical system is to observe and measure the image of a point source, also called the Point Spread Function (PSF). The shape and the size of this image depend on the aberrations of the optical system. A perfect system is diffraction limited, i.e. the PSF is

an Airy pattern for a circular pupil. The measurements can be made with a microscope viewer and can be performed either with the eye or with a camera. (see figure 1.

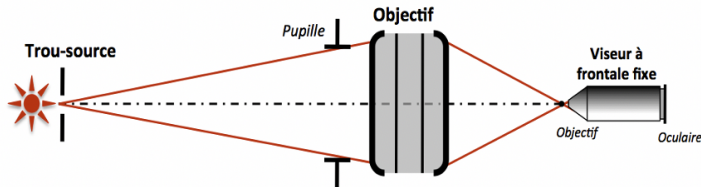

Figure 1: Experimental set-up

Defocusing the observation plane slightly around the best focus plane gives much more information about the aberrations of the system.

The system is usually studied for on-axis conjugation, but also off-axis, either by moving the source in the object plane or by rotating the objective. If we want to study the optical system for an infinite-focus conjugation, we place the source hole at a large distance from the focal length of the system under study (Lab1) or at the focus of a collimator with a small aperture and excellent quality (Lab2).

1.1 How to choose the light source?

Study of aberrations for a precise wavelength (quasi monochromatic light):

Spectral lamp, white lamp with a colored filter, colored LED

Study of chromatic aberrations: white source and possibly a monochromator.

Warning : It is crucial to systematically make sure that the pupil of the system under test is fully illuminated otherwise the aberrations would be grossly underestimated. If required, a condenser can be inserted between the light source and the point source to ensure that the optical system under test is fully illuminated.

1.2 How to choose the pinhole?

Ideally, the point source should be infinitely small in order to measure the PSF size of the optical system under test. In practice, however, the pinhole has a finite size. The observed image is actually the convolution of the PSF that we

want to study by the geometrical image of the pinhole. The geometrical image of the pinhole should thus be kept small with respect to the PSF diameter. For an optical system with a circular pupil, the smallest PSF is the Airy spot. On the other hand, the observation may be difficult by lack of light if the pinhole is too small. The diameter of the pinhole should thus be adapted to the aberrations of the system under test

For small aberrations (lenses that are nearly diffraction limited), the geometrical image of the pinhole diameter should typically be smaller than $1/4$ of the Airy dark ring diameter in the image plane.

For large aberrations, choose a pinhole with a larger diameter to compensate for the spreading of light, whilst keeping the pinhole geometrical image smaller than the dimension of the PSF.

1.3 How to choose the microscope objective?

Numerical aperture of the microscope objective: the system under test must be the pupil of the whole set-up. Therefore, the numerical aperture of the microscope objective must be larger than the image numerical aperture of the system under test.

Microscope objective magnification ratio: the PSF must be sufficiently magnified to be observed easily. However, the size of the PSF should not exceed the full field of view of the microscope viewer. You should thus start with a moderate magnification ratio, and increase it progressively if necessary.

2 Wavefront measurements

Both the ZYGO and the HASO measure the wavefront error, but they use two different methods. The ZYGO, which is based on the Fizeau interferometer, uses an interferometric approach, while the HASO approach, based on the Shack-Hartmann analysis, is a geometrical measurement. In both cases, the data processing allows a quantitative analysis of the contribution due to the various aberrations, the PSF, the spot diagram, and MTF of the tested optical system.

2.1 Interferometric measurement of a wavefront

The Zygo interferometer analyzes interferences between a reference plane wavefront that has been reflected by a glass reference plane and a plane wavefront that has propagated forth and back through the objective. The back-reflection

is provided by a spherical reference mirror. The center of curvature of the spherical mirror is on the objective best focus.

2.2 Geometrical measurement of a wavefront

Following the Shack-Hartmann method, an array of micro-lenses samples the wavefront and enables the measurement of the local slopes of the wavefront. The software reconstructs the wavefront in real time from the slopes measurements. This is very useful for alignment of the optical system under test. By comparison with a ZYGO interferometer, a Shack-Hartmann analyzer has a lower spatial resolution. It is not suited for optical systems with a large image numerical aperture.

2.3 Decomposition of the wavefront on the Zernike polynomials basis

It is possible to evaluate the various geometrical aberrations contribution by decomposing the wavefront defect on the Zernike polynomials orthogonal basis (for circular pupils only). Note that the HASO also propose a decomposition over Legendre polynomials which is adapted for rectangular pupils. The decomposition over the Seidel basis remains widely used for the 3rd order aberrations. The relationships between the Seidel amplitudes and the Zernike coefficients (see Table 1 below) are the following (for systems which have only 3rd order aberrations):

	Seidel (3rd order)	Peak to valley amplitude
Spherical aberration	$\Delta_{\max} = 6 \times C_8^{-1}$	$\Delta_{PV} = \Delta_{\max}$
Coma	$\Delta_{\max} = 3\sqrt{C_6^2 + C_7^2}$	$\Delta_{PV} = 2 \times \Delta_{\max}$
Astigmatism	$\Delta_{\max} = \sqrt{C_4^2 + C_5^2}$	$\Delta_{PV} = 2 \times \Delta_{\max}$

Table 1: The relationships between the Seidel amplitudes and the Zernike coefficients

C1	$u \cos \varphi$	Basculement	
C2	$u \sin \varphi$		
C3	$2u^2 - 1$	Défaut de mise au point	
C4	$u^2 \cos 2\varphi$	Astigmatisme	3 ^{ème} ordre
C5	$u^2 \sin 2\varphi$		
C6	$(3u^2 - 2)u \cos \varphi$	Coma	
C7	$(3u^2 - 2)u \sin \varphi$		
C8	$6u^4 - 6u^2 + 1$	Aberration sphérique	
C9	$u^3 \cos 3\varphi$	Trèfle	5 ^{ème} ordre
C10	$u^3 \sin 3\varphi$		
C11	$(4u^2 - 3)u^2 \cos 2\varphi$	Astigmatisme	
C12	$(4u^2 - 3)u^2 \sin 2\varphi$		
C13	$(10u^4 - 12u^2 + 3)u \cos \varphi$	Coma	
C14	$(10u^4 - 12u^2 + 3)u \sin \varphi$		
C15	$20u^6 - 30u^4 + 12u^2 - 1$	Aberration sphérique	
C16	$u^4 \cos 4\varphi$	Aberration quadrifoliée	7 ^{ème} ordre
C17	$u^4 \sin 4\varphi$		
C18	$(5u^2 - 4)u^3 \cos 3\varphi$	Trèfle	
C19	$(5u^2 - 4)u^3 \sin 3\varphi$		
C20	$(15u^4 - 20u^2 + 6)u^2 \cos 2\varphi$	Astigmatisme	
C21	$(15u^4 - 20u^2 + 6)u^2 \sin 2\varphi$		
C22	$(35u^6 - 60u^4 + 30u^2 - 4)u \cos \varphi$	Coma	
C23	$(35u^6 - 60u^4 + 30u^2 - 4)u \sin \varphi$		
C24	$70u^8 - 140u^6 + 90u^4 - 20u^2 + 1$	Aberration sphérique	
C25	$u^5 \cos 5\varphi$	Aberration pentafoliée	9 ^{ème} ordre
C26	$u^5 \sin 5\varphi$		
C27	$(6u^2 - 5)u^4 \cos 4\varphi$	Aberration quadrifoliée	
C28	$(6u^2 - 5)u^4 \sin 4\varphi$		
C29	$(21u^4 - 30u^2 + 10)u^3 \cos 3\varphi$	Trèfle	
C30	$(21u^4 - 30u^2 + 10)u^3 \sin 3\varphi$		
C31	$(56u^6 - 105u^4 + 60u^2 - 10)u^2 \cos 2\varphi$	Astigmatisme	
C32	$(56u^6 - 105u^4 + 60u^2 - 10)u^2 \sin 2\varphi$		
C33	$(126u^8 - 280u^6 + 210u^4 - 60u^2 + 5)u \cos \varphi$	Coma	
C34	$(126u^8 - 280u^6 + 210u^4 - 60u^2 + 5)u \sin \varphi$		
C35	$252u^{10} - 630u^8 + 560u^6 - 210u^4 + 30u^2 - 1$	Aberration sphérique	
C36	$924u^{12} - 2772u^{10} + 3150u^8 - 1680u^6 + 420u^4 - 42u^2 + 1$	Aberration sphérique	11 ^{ème} ordre

Table 2: Polynomials used by ZYGO and HASO. u is the normalized height in the pupil, φ is the azimuthal angle.

2.4 PSF simulation

From the measured wavefront error in the pupil, i.e. the Optical Path Difference, both HASO and ZYGO can simulate the image spot of the optical system

under test.

Geometrical analysis: Spot Diagram

Rays being perpendicular to the wavefront, it is straightforward to deduce the intersections of the rays with the image plane. This geometrical approach gives the Spot diagram. For a perfect system the spot diagram is a single point (stigmatism).

Fourier Analysis : PSF and MTF A wavefront analyzer measures the wavefront error at every point of the pupil. Assuming that the pupil is uniformly illuminated, the amplitude of the electromagnetic field in the pupil is related to the wavefront error by:

$$P(X, Y) = a_0 e^{j\varphi(X, Y)} = a_0 e^{-j2\pi \frac{\Delta(X, Y)}{\lambda}}$$

where a_0 is the amplitude and λ is wavelength of the wavefront.

The incoherent Point Spread Function (the image spot) $\text{PSF}(X', Y')$, is calculated by Fourier Transform:

$$\text{PSF}(\vec{r}') = \text{PSF}(\vec{r}') \propto |\text{TF}(P(X, Y))|_{\frac{\vec{r}'}{\lambda D}}^2$$

where D is the distance between the pupil and the focusing plane. The PSF of a diffraction limited optical system with a circular pupil is an Airy pattern: it is the smallest image of a point source that an optical system can form. The diameter of the first dark ring of the Airy pattern, including 84% of the total energy of the PSF, is $\varnothing_A = 1,22\lambda \sin \alpha'_{\max}$. L'expression de l'éclairement dans le plan image dans ce cas est :

$$\text{PSF}(\vec{r}') = E_{\text{Airy}}(\vec{r}') = \left(\frac{A_0}{\lambda D}\right)^2 (\pi h_{\max}^2)^2 \times \left(\frac{2J_1\left(\frac{2\pi}{\lambda} \sin \alpha'_{\max} \times r'\right)}{\frac{2\pi}{\lambda} \sin \alpha'_{\max} \times r'}\right)^2$$

where α'_{\max} is the maximum image aperture angle. The encircled energy inside the \varnothing_A diameter drops quickly in presence of aberrations. Comparing the PSF of the system under test with the Airy spot limit is a good way to evaluate how important the defects of the system are.

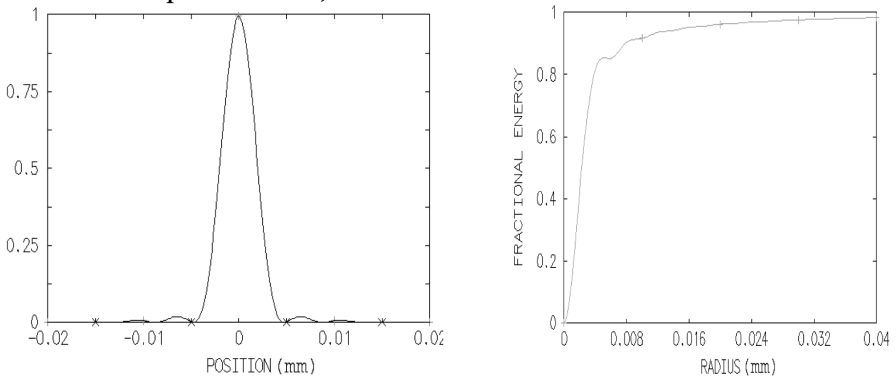

Figure 2: PSF of a diffraction limited lens with a numerical aperture of 0,08 for $\lambda = 633$ nm (left). Corresponding encircled energy of the Airy pattern (right)

The Strehl ratio, R_S , is the ratio between the maximum of the measured PSF and the maximum of the ideal (i.e. diffraction limited) PSF. The Maréchal criterion stipulates that, for visual observations, an optical system can be considered as diffraction limited if $R_S \geq 80\%$ which corresponds to $\sigma_\Delta \leq 0,07\lambda \approx \lambda/14$. In practice, values of R_S below 0.2 are not relevant to describe the quality of an optical system.

The Modulation Transfer Function (MTF) is another way to evaluate the defects of an optical system that is illuminated by incoherent light. It is the Fourier Transform of the PSF. The MTF, is the autocorrelation of the field amplitude in the pupil.

$$\text{FTM}(\vec{\omega}') = \text{TF} \left[\text{PSF}(\vec{r}') \right]_{\vec{\omega}'} = \frac{(P \otimes P)_{\lambda D \vec{\omega}'}}{(P \otimes P)_{\vec{0}}}$$

The Modulation Transfer Function yields the contrast in the image formed by the optical system when the object is a sinusoidal test pattern. The MTF is usually plotted versus the spatial frequency ν , measured in the image plane. Comparing the MTF of the system under test with the MTF of a diffraction limited system with the same numerical aperture (see figure 3) is also a good way to evaluate how much the aberrations of the system degrade the quality of the image.

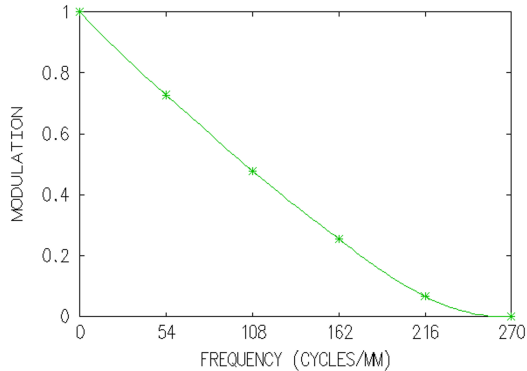

Figure 3: MTF of a diffraction limited lens with a numerical aperture of 0,08 for $\lambda = 633$ nm.

The cut-off frequency of a diffraction limited system is given by:

$$\nu_c = \frac{2 \sin \alpha'_{\max}}{\lambda}$$

where $\sin \alpha'_{\max}$ is the numerical aperture (NA) of the system under test, in the image space. However it is often useful to define a cut off frequency at 10%, because below this value the image is generally too aberrated to be used. Note that the MTF contains exactly the same information as the PSF: one is merely the Fourier Transform of the other. It is just another way to evaluate the aberrations of an imaging system.

2.5 Important remark on the wavefront

The wavefront defect measurement should be performed in a conjugate plane of the output pupil of the system. Otherwise, the propagation would lead to a deformation of the wavefront, which is particularly visible on the edge of the pupil when the focus adjustment is not accurate. The ZYGO has a CAM adjustment option (a motorized lens) that allows the output pupil of the optical system under test to be conjugated with the plane where the interference pattern is recorded. In the case of the HASO labwork, this condition is not fulfilled. This may lead to measurement errors.

Specification of the lenses

Lab 1-2-3

Plano-convex singlet

$$f' = 150 \text{ mm}(\pm 1\%) - \emptyset = 25 \text{ mm} - \text{NA} = 0,08.$$

Clairaut-Mossotti doublet (Thorlabs AC254-150-A1)

$$f' = 150 \text{ mm}(\pm 1\%) - \emptyset = 25 \text{ mm} - \text{NA} = 0,08.$$

There is no air space between the two lenses. The pair of glasses is BK7/SF5. It was designed to be aplanatic (i.e. no spherical aberration and no coma) and achromatic in the visible range.

Magnifying objective

$$f' = 150 \text{ mm}(\pm 1\%) - \text{Iris diaphragm}$$

The characteristics of this objective will be measured precisely during the lab sessions. It was designed to magnify pictures taken with a 24 mm × 36 mm ISO200 film. The diameter of the grain of an ISO200 film is approximately 20 μm.

Plano-convex singlet (Nominal orientation)

Glass : BK7 – $f' = 150 \text{ mm}(\pm 1\%) - \emptyset = 25 \text{ mm} - \text{NA} = 0,08.$



Figure 4: Spot-diagram and PSF at paraxial focus on axis ($\lambda = 633 \text{ nm.}$)

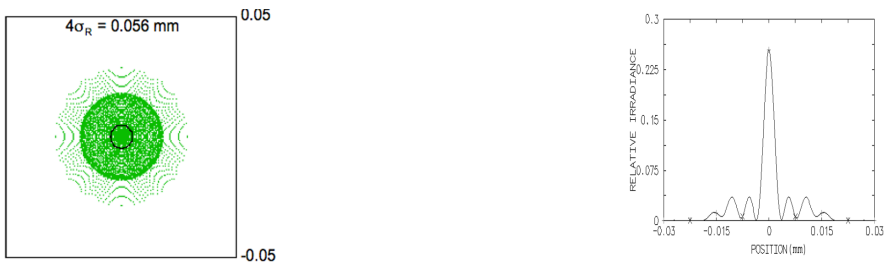

Figure 5: Spot-diagram and PSF at best focus on axis ($\lambda = 633 \text{ nm.}$)

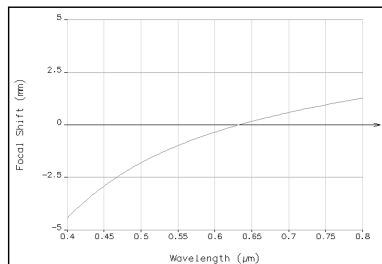

Figure 6: Longitudinal chromatism

Doublet Thorlabs AC254-150-A1

$$f' = 150 \text{ mm}(\pm 1\%) - \emptyset = 25 \text{ mm} - \text{NA} = 0,08.$$

SRF	RADIUS	THICKNESS	AP. RADIUS	GLASS
1	91.62	5.70	12.50	BK7
2	-66.68	2.20	12.50	SF5
3	-197.70	146.29	12.50	AIR

Table 3: LENS DATA

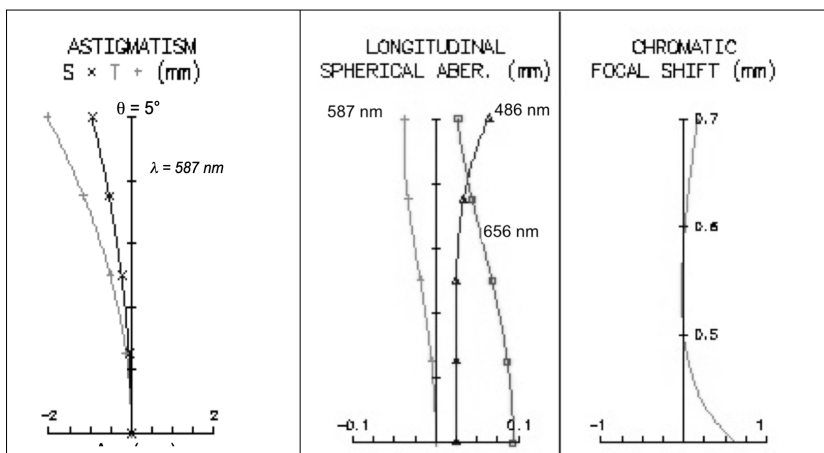

Figure 7

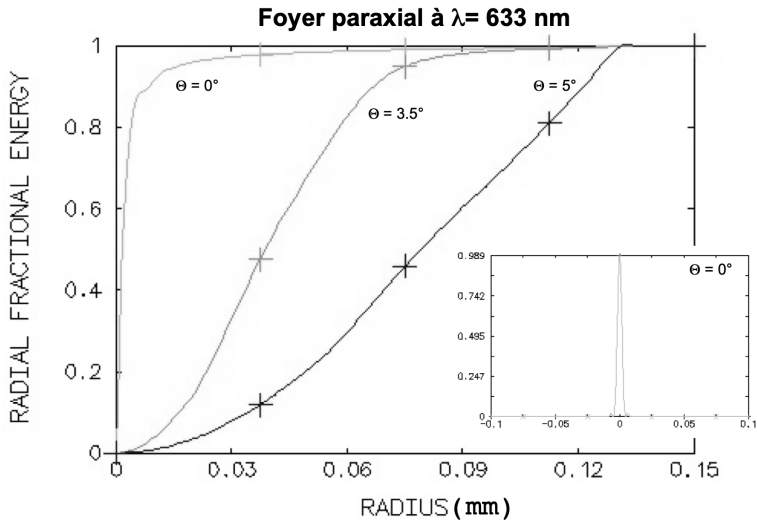

Figure 8

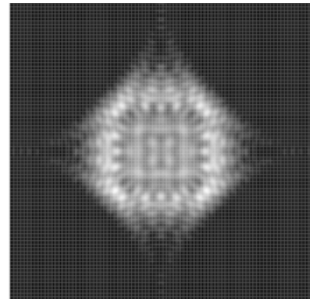
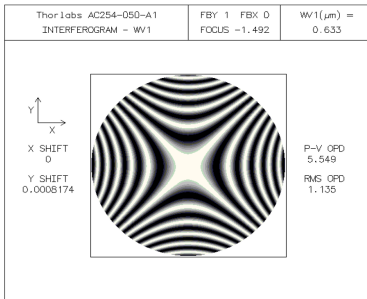

Figure 9: Theoretical interferogram at best focus (left) and PSF simulation at best focus, (right, image size $160 \mu\text{m}$), $\theta = 5^\circ$, $\lambda = 633$ nm

A 1

On-axis aberrations using the "point source method"

In this lab session, you will study and compare the on-axis aberrations of three optical systems using the “point source method”, i.e. spherical aberration and axial chromatism. The optical systems are the following: a plano-convex singlet, a Clairaut – Mossotti doublet, and a magnifying objective. The characteristics of these systems are given in the global presentation (pages 12 à 14). In particular, you will compare the performance of the singlet and the doublet, which have the same focal length and the same numerical aperture.

Preparatoy work read carefully the principle of the point source method presented in the introductory part (paragraph 1, page 2) and in the text below. Do the preliminary calculations.

Contents

1	Reminders	15
2	Experimental set-up	18
3	Lab work	21

1 Reminders

1.1 Chromatism and glass dispersion

The dispersion of a transparent optical medium is defined as the variation of its refractive index n as a function of the wavelength λ . This function is usually regularly decreasing in the visible domain. So, it is possible to characterize a

glass by the mean value of the index \bar{n} and by the variation Δn of the index over the visible domain. In fact, instead of Δn , we use the constringency (also called Abbe number), defined as $\nu = \frac{\bar{n}-1}{\Delta n}$, which is a useful quantity to calculate the chromatic aberrations:

$$\nu_d = \frac{n_d - 1}{n_F - n_C}$$

where d , F and C denote the spectral rays given in the table 1.1:

ry	element	color	wavelength (nm)
d	Helium	yellow	587,6
F	Hydrogen	blue	486,1
C	Hydrogen	red	656,3

Table 1.1: Spectral rays d , F et C

The available glasses may be represented in a graph (ν, n) . as shown on figure 1.1.

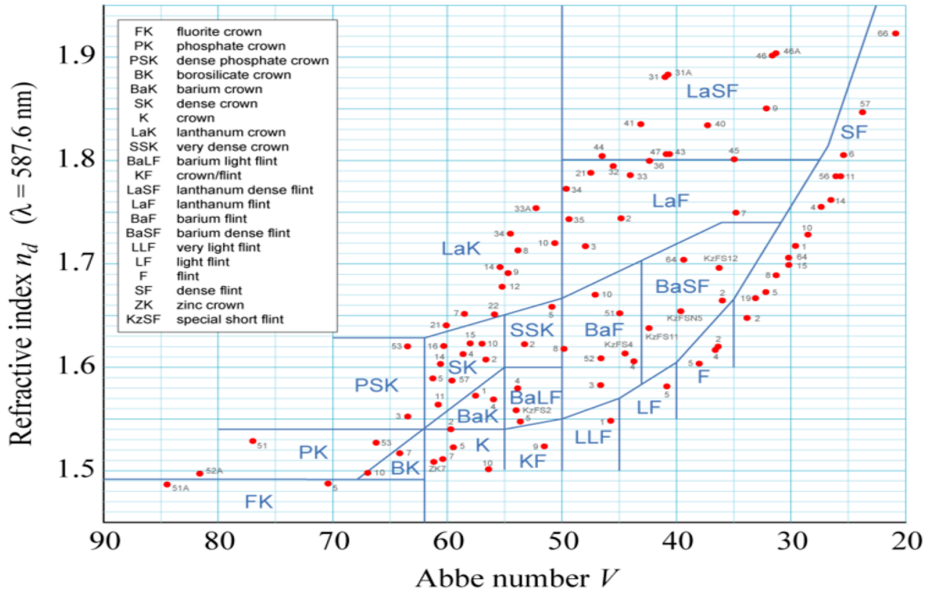

Figure 1.1: different glasses in the (ν, n) plane

Reminder: For a singlet, the evolution of its focal length with the wavelength in the visible range is given by: $\delta f' = f'_B - f'_R = -\frac{f'}{v_d}$.

P1 Evaluate the longitudinal chromatism $\delta f'$ of the studied singlet.

1.2 Third order spherical aberration

Spherical aberration appears on axis and remains constant all over the field. It appears when the aperture of the system becomes too wide to predict the ray trajectory using paraxial calculation. Spherical aberration creates a variation of the focal plane depending on the height of impact of rays in the pupil. Within the 3rd order approximation, using a purely geometrical approach (no diffraction), it can be shown that spherical aberration has the following properties:

- Axial caustic length :

$$l(\alpha') = \overline{F'_p F'_{\alpha'}} = a\alpha'^2$$

where α' is the image aperture angle

- PSF radius at paraxial focus:

$$dy' = -l(\alpha') \times \alpha' = -a\alpha'^3$$

- Optical path delay (OPD) at paraxial focus:

$$\Delta\alpha' = -\frac{a}{4}\alpha'^4$$

For a plano-convex singlet in the infinite-focus conjugation For a plano-convex singlet in the infinite-focus conjugation, the coefficient denoted as a which characterizes the amplitude of spherical aberration, is given by:

- In the nominal orientation:

$$a = \frac{n^3 - 2n^2 + 2}{2n(n-1)^2} f'$$

- In the wrong orientation (convex surfaces towards the focus):

$$a = \frac{n^2}{2(n-1)^2} f'$$

P2 What is the theoretical diameter of the PSF of the studied singlet, in both orientations, at paraxial focus? Compare these calculations with the Airy diameter and the OSLO simulations. (page 12). And at the focus of least confusing circle?

P3 What is the theoretical caustic length of the spherical aberration?

2 Experimental set-up

During this session, you will implement two different set-ups:

- One using a white light source followed by a monochromator and a fixed front focus visor. It will allow you to directly observe the point spread function and to measure the longitudinal chromatism of the systems. The point source is placed far away from the lens under test.
- One using a fibered laser diode at $\lambda = 635 \text{ nm}$ and a CMOS camera to capture the point spread function and compare it to the diffraction limit. The source is placed at the object focal point of a collimator.

2.1 First set-up: monochromator and fixed front focus visor

During this experiment we will visually study with a microscope the on axis aberrations of optical systems on an infinite-focus conjugation (figure 1.2).

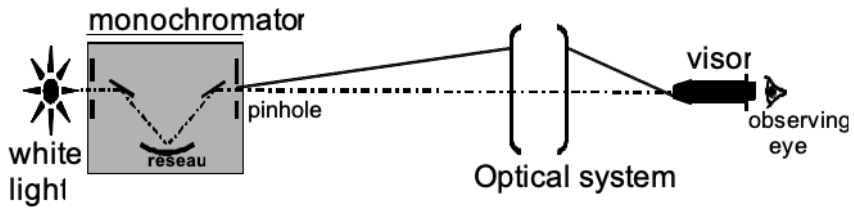

Figure 1.2: Schematic of the first set-up

How to choose the pinhole diameter? To measure the aberrations of such systems the object must be a point source located at infinity (i.e. at least at a distance ten times superior to the focal length of the lens under test, or in the focal plane of a collimator). In practice, the pinhole should be sufficiently small so that its geometrical image does not limit the resolution of the observation. On the other hand, it should give an acceptable amount of light (see general presentation). The pinholes at your disposal have the following diameters: $50\ \mu\text{m}$, 0, 1 mm, 0, 2 mm, 0, 3 mm, 0, 5 mm and 1 mm.

The monochromator The light source used for this set-up is a white iodine lamp filtered by a monochromator (Jobin-Yvon H10) located at approximately 6 meters from the lens under test (figure 1.3).

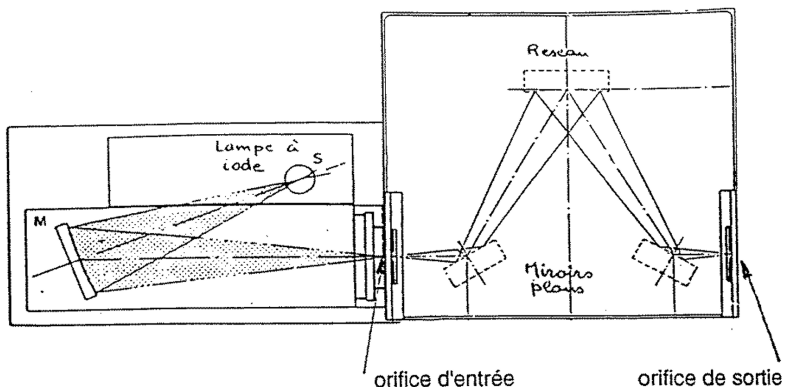

Figure 1.3: Schematic of the monochromator

The spectral resolution (κ) is $8\ \text{nm/mm}$ for a wavelength in the center of the visible spectrum, It means that an 1 mm input slit (or output) correspond to a 8 nm spectral width.

P4 Evaluate the spectra width for a 3 mm input slit and a correctly calculated output pinhole to measure the PSF.

2.2 Second set-up: fibered laser diode and CMOS camera

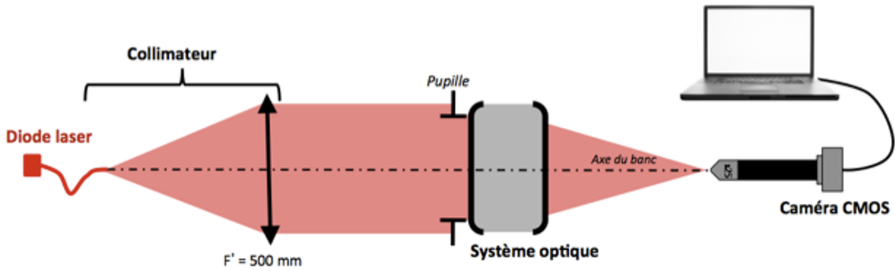

Figure 1.4: Schematic of the second set-up

The light source used on this set-up is a laser diode emitting at a wavelength of $\lambda = 635 \text{ nm}$. The SM600 monomode fiber has a mode diameter of $4,3 \mu\text{m}$ and a numerical aperture of approximately 0,10 at the source wavelength. The diode is powered by a stabilized ILX Lightwave power supply which can adjust the intensity and thus the emitted flux up to 40 mA.

The collimator is made with a doublet ($f' = 500 \text{ mm}$), and allows to study the lenses with an infinite-focus conjugation. During the experiment, the collimator will be used to study the systems on axis.

P5 What is the diameter of the image of the fiber in the focal plane image of the doublet, focal length $f' = 150 \text{ mm}$? Compare to the PSF of a diffraction limited lens (Airy's spot).

Microscope and camera. The image spot is observed with a microscope objective of $\times 10$ ou $\times 25$ camera of $1,45 \mu\text{m}$ square pixels, and of total dimension $5,66 \text{ mm} \times 3,15 \text{ mm}$. The image is digitized over 8bits (0 to 255 gray level). It is controlled with the uEye Demo software and the pictures are analyzed using the Matlab Script `Mesure_PSF`.

↪ Be careful during your measurements that the detector is not saturated. If so, adjust the Exposure Time and/or the power supply of the source. The software manuals are at your disposal in the lab room.

3 Lab work

3.1 Singlet study on the first set-up

$$f' = 150 \text{ mm}(\pm 1\%) - \emptyset = 25 \text{ mm} - \text{NA} = 0,08.$$

Spherical aberration of the singlet lens

The monochromator is located at 6 meters of the studied optical system.

↪ At start, adjust the wavelength at $\lambda = 546 \text{ nm}$ and remove both entrance slit and exit pinhole.

Point source and microscope objective selection

Q1 Calculate the image plane position in relation to the image focal plane and the magnification of this set-up.

Q2 Calculate the Airy disk diameter in this plane for an ideal optical system with the same numerical aperture than the singlet.

Q3 Deduce the pinhole diameter to use for a diffraction limited optical system.

Q4 Explain why the numerical aperture of the microscope objective should be greater than 0.08, the numerical aperture of the studied doublet.

First observations

↪ Place the plano-convex singlet in the chuck in the nominal direction.

↪ To quickly find the image using the microscope objective, do not use any pinhole at the monochromator output and use an objective with a small magnification.

↪ Place the pinhole only when the image is correctly focus and centered.

↪ Adjust the chuck orientation to get a circular image.

↪ To observe and analyze the point spread function, do not stay in the best focus plane but on the contrary observe the evolution of the out of focus image around this position.

Q5 What other aberration(s) appear when the source is not on-axis?

↪ Determine the position of the paraxial focus and the best focus and measure the distance between those 2 positions.

Q6 Draw a clear sketch to explain those positions.

↪ Call the professor to cross-check your alignment, observations and measurements.

PSF measurements

↪ Measure the PSF diameter at the paraxial focus and at the best focus.

Q7 Try to evaluate your measurement accuracy. Even if you are very cautious, it can't be less than 20-25%.

↪ Add the 12,5 mm and redo those measurements.

Q8 Compare your measurements with your theoretical calculations based on the third order theory and with the spot diagrams calculated with an optical design software (page 12).

↪ Measure the caustic length using the annulus diaphragm.

Q9 Compare it with the theoretical calculation.

↪ Make the same measurements with the lens in the wrong orientation.

Chromatism

↪ Now place the 3 mm slit at the monochromator entrance. The spectral width is now about 24 nm.

↪ If the image spot is not bright enough for some wavelength, adjust the pinhole size at the output of the monochromator.

↪ Vary the wavelength and measure the paraxial focus position for the singlet. Vary from 450 to 700 nm with a step of the order of 50 nm, not forgetting the lines $F(486\text{ nm})$, $d(587.6\text{ nm})$ and $C(656\text{ nm})$ used for the definition of the constringency in the visible domain.

Q10 Trace the variation of the foci $\overline{F'_C F'_\lambda}$ as a function of wavelength λ .

Q11 Compare your results with the simulations made with datasheets. What is the principal axial chromatism (between F and C rays of hydrogen) for the singlet?

Q12 Evaluate experimentally your accuracy on your measurements of $\overline{F'_C F'_\lambda}$ and add the uncertainty bars on your figure. Also take into account the uncertainty on the wavelength and add the corresponding bars.

In practice, the point source is located at a finite distance so you measured the evolution of the position of A' , the image of the point source which is located near F' , the focus.

Q13 In the approximation of thin lenses, calculate the position of A' , and the correction factor to apply on your measurements of $\overline{A'_C A'_\lambda}$ to have $\overline{F'_C F'_\lambda}$ and correct your graph.

Q14 Is your accuracy the same on the edges of the spectrum and for the central wavelengths? Why?

Q15 Deduce from your results the constringency ν_d of the glass the lens is made of. What type of glass could it be? What is your uncertainty on the constringency?

3.2 On-axis doublet study on the first set-up

$$f' = 150\text{ mm}(\pm 1\%) - \emptyset = 25\text{ mm} - \text{NA} = 0,08.$$

PSF measurements

↪ Adjust the monochromator at $\lambda = 546 \text{ nm}$.

↪ Place the doublet in the wrong orientation and quickly evaluate the spherical aberration (PSF and caustic length). Compare those values to those from the singlet characterization in the best orientation.

↪ Place the doublet in the nominal orientation and carefully analyze the image spot.

Q16 Comment the apparition or not of a black center when you slightly defocus around the best focus (in both directions). Explain why this test shows that the doublet is almost ideal for this conjugation.

↪ Measure the diameter of the image spot and compare it to the Airy pattern size.

Secondary chromatism of the doublet:

↪ Now place the 3 mm at the monochromator entrance. If the image spot is not bright enough for some wavelength, adjust the pinhole size at the output of the monochromator

For a doublet, the primary chromatism should be corrected.

↪ Measure the position of the pinhole image for the 3 reference wavelengths given in table 1.1.

↪ Check that the primary axial chromatism, $\overline{F'_C F'_F}$, is close to zero, and evaluate the secondary chromatism, $\overline{F'_d F'_F}$.

Q17 Compare your results from the simulations.

↪ **Move on to the second set-up**

3.3 Singlet study on the second set-up

↪ Place the singlet in the nominal orientation in the chuck. Launch the Ueye Cockpit software to display the PSF and find the best focus.

↪ Save the image and launch the `mesure_PSF` script in Matlab.

↪ Measure the encircled energy radius at 80%.

Q18 Compare it to your results in the first setup.

3.4 On-axis doublet study on the second set-up

↪ Adjust the doublet orientation (in the nominal orientation) so that it works on axis. To do that, rotate the chuck until the PSF is rotationally symmetric. Check if the doublet is diffraction limited. Observe the evolution of the PSF around the best focus.

↪ Using the script `measure_PSF`, measure the Airy pattern diameter and compare it to your visual observations from set-up 1.

The experimental plot might be above the experimental one for a stigmatic system.

Q19 Explain this error.

3.5 Magnifying objective study

↪ For $N = 4, 5.6, 8$ et 11 , using the same method, measure the encircled energy radius at 80%

Q20 Trace this radius as a function of F-number.

↪ Which aperture gives the best resolution? What is the highest aperture giving a diffraction limited PSF ?

A 2

Off-axis aberrations using the "point source method"

In this lab session, you will study the off-axis aberrations of two lenses in infinite-focus conjugation. Firstly, you will study the astigmatism and field curvature of a Clairaut – Mossotti doublet, which is virtually corrected of spherical aberration and coma. Then, you will characterize a standard magnifying objective over its full field.

Preparatoy work read carefully the principle of the point source method presented in the introductory part (paragraph 1, page 2) and in the text below. Do the preliminary calculations.

Contents

1	Reminders	27
2	Experimental set-up	30
3	Lab work	32

1 Reminders

1.1 Third order coma

Coma is an off-axis aberration that leads to a PSF that resembles a comet. Coma is related to the fact that, when the field dimension and the aperture angle become large, Abbe's formula (aplanatic system) $ny \sin(\alpha) = n'y' \sin(\alpha')$ is not valid anymore. Within the 3rd order approximation, the characteristic

dimension ρ of a coma PSF is given by:

$$\rho = by' \sin^2(\alpha')$$

with

- α' the image numerical aperture angle,
- b the coma parameter,
- y' the image position in the field.

The length of the coma PSF is then 3ρ and its width is 2ρ (see figure 2.1). The coma varies linearly with the field and quadratically with the aperture.

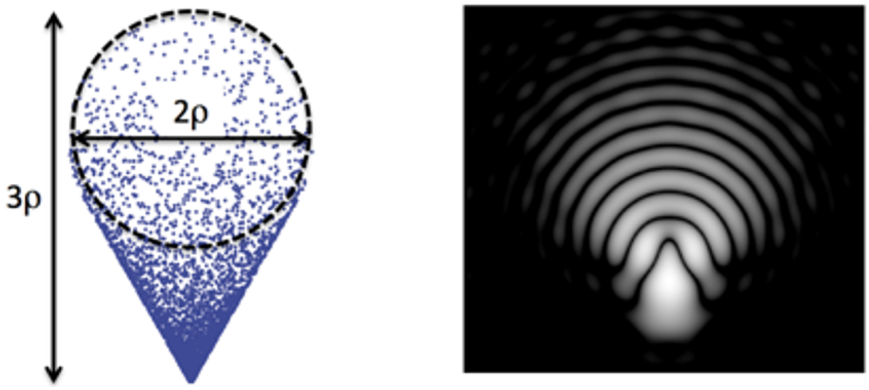

Figure 2.1: Coma spot diagram and definition of ρ parameter. PSF(right)

The associated wavefront error is given by : $\Delta_{coma}(\varphi) = by'\alpha'3 \cos \varphi$.

1.2 Astigmatism and field curvature

The field curvature describes how the image of a plane is curved. The astigmatism describes how the PSF takes the shape of a small segment (either tangential or sagittal depending on the focus) or a small diamond shape at the best focus. (see figure 2.2 and figure 2.3 : focal lines).

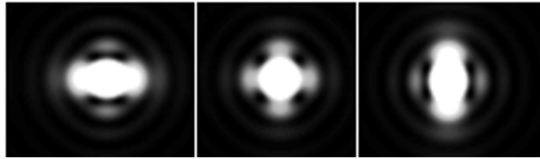

Figure 2.2: PSF shape for a small astigmatism (0.37λ) at sagittal focus, best focus and tangential focus.

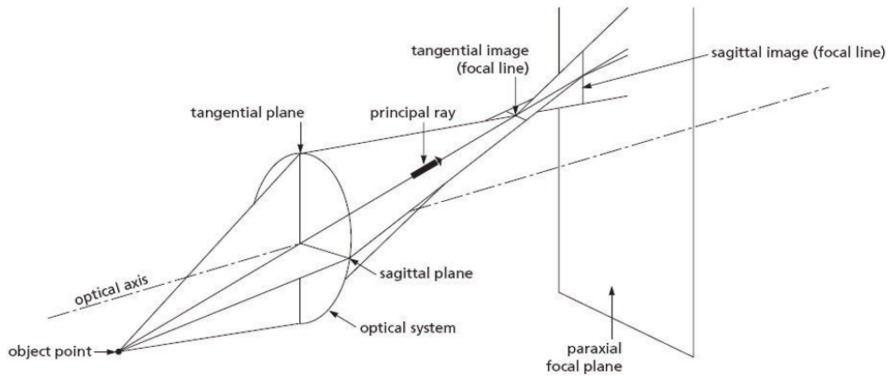

Figure 2.3

s and t are the projected distances on the optical axis between S and T foci and the paraxial focal plane (see figure 2.4 below).

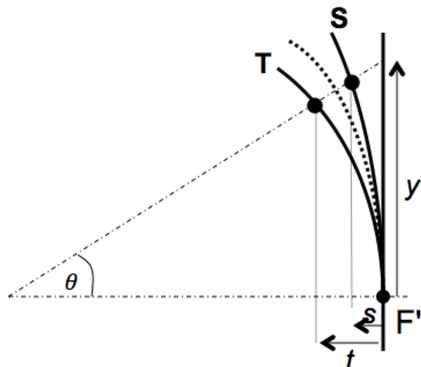

Figure 2.4

In the 3rd order approximation, those distances vary quadratically in the field, and the best focus is in the middle of sagittal and tangential foci.

$$s = C_S \frac{y'^2}{2} \quad \text{and} \quad t = C_T \frac{y'^2}{2}$$

We define: $\mathcal{A} = \frac{(C_S - C_T)}{2}$, and $\mathcal{C} = \frac{(C_S + C_T)}{2}$

- The sagittal foci PSF sizes are: $2\mathcal{A}y'^2\alpha'_{\max}$
- The width of the PSF at the best focus is: $\mathcal{A}y'^2\alpha'_{\max}$.
- The wavefront error is:

$$\Delta_{\text{ast}} = \frac{\mathcal{A}}{4} y'^2 \alpha'^2 \cos(2\varphi)$$

For a thin lens, the field curvature:

$$\mathcal{C} = \frac{-2}{f'} - \frac{1}{nf'}$$

And the astigmatism is:

$$\mathcal{A} = \frac{C_S - C_T}{2} = \frac{1}{f'}$$

P1 Theoretically evaluate the astigmatism \mathcal{A} and the field curvature \mathcal{C} of the studied doublet from its characteristics. Also evaluate the C_S and C_T curvatures. Compare with simulations.

P2 What is the expected size of the PSF at the best focus for a 5° field angle?

2 Experimental set-up

The experimental set-up is there based on the use of a collimator (focal length 500 mm) which allows to have a source at infinity. The angular size of the object is given by the pinhole diameter placed at the collimator focus. You can choose between several values: $\varnothing = 12, 5 \mu\text{m}, 50 \mu\text{m}, 100 \mu\text{m}, 400 \mu\text{m}, 5 \text{mm}$. The object under test is placed in a chuck, with adjustable orientations. The rotation of the collimator allows to explore the field. The experiment is summarized in the scheme on figure 2.5.

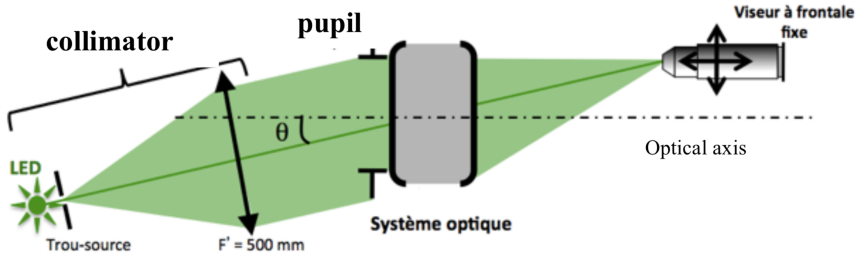

Figure 2.5: Schéma du montage utilisé

2.1 The light source

Four light sources are available for this set-up. Three colored LED (red $\lambda = 630$ nm, green $\lambda = 530$ nm, blue $\lambda = 470$ nm) and a white LED.

P3 Evaluate the Airy pattern diameter for the optical systems on test and for the three wavelengths.

2.2 The pinhole

The collimator ($f' = 500$ mm) allows to study the objective for an infinite-focus conjugation. You have to choose the pinhole you put in its object focal plane (diameters available: $\varnothing = 12,5 \mu\text{m}$, $50 \mu\text{m}$, $100 \mu\text{m}$, $400 \mu\text{m}$, 5 mm).

P4 Evaluate the maximal diameter of the pinhole acceptable to observe the point spread function if the system is diffraction limited.

P5 What is the geometric diameter of the image of the hole in the focal plane of the objective system under test? If the image is too shallow, we might need to use a bigger hole to ensure observation quality but we must check that the geometrical image of the pinhole stays smaller than the PSF.

2.3 Translation of the microscope viewer and the collimator

Both the collimator and the microscope viewer are mounted on motorized stages (translation and rotation stages, respectively), which allow you to study the off-aberrations of the lens under test on a wide range of field angles and with a high accuracy. Each stage can be displaced manually. The front panel of the stages controller is shown on 4.4:

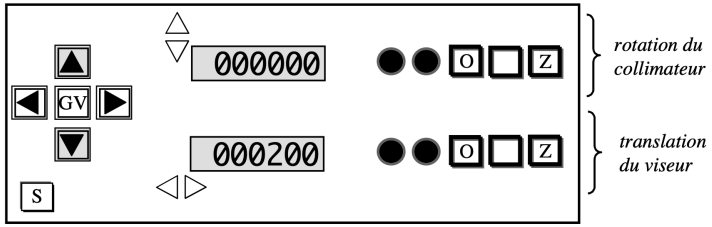

Figure 2.6: Front panel of the stages controller

2.4 Microscope objective choice

Warning the optical system to study must be the pupil of the set-up

For each of the studied optical systems:

P6 Calculate the minimal numerical aperture needed for the microscope objective.

P7 What is the other constraint on the microscope objective aperture for the off axis analysis?

2.5 Fine orientation adjustments of the studied objective

~> By observing the image spot, adjust the orientation of the objective so that the image of the source hole is rotationnaly symmetric. This adjustment is more precise than one using a laser.

3 Lab work

3.1 Doublet in the nominal orientation

$$f' = 150 \text{ mm}(\pm 1\%) - \emptyset = 25 \text{ mm} - \text{NA} = 0,08.$$

On axis analysis of the spot

Pinhole choice and the microscope objective

Q1 Evaluate the Airy pattern diameter (for the wavelengths of the LED sources of the collimator) for an ideal optical system with the same numerical aperture than the doublet.

Q2 Deduce from this the hole diameter to use for a diffraction limited system.

Q3 Explain why the object numerical aperture of the microscope objective must be higher than 0.08, the image numerical aperture of the doublet.

PSF measurements on axis

↪ Place the doublet in the nominal orientation in the chuck.

↪ To quickly find the image using the microscope, start by the biggest hole, find the image, center it and reduce the pinhole diameter.

↪ Carefully adjust the chuck orientation to have a rotationnaly symmetric image spot.

↪ o observe and analyze the PSF, look the evolution of the image before and after the best focus.

Q4 Is the doublet diffraction limited?

↪ Measure the PSF diameter at the best focus for all 3 wavelengths and under white illumination.

Q5 Compare it to the Airy pattern diameter.

↪ Add the 12,5 mm diaphragm and redo those measurements.

Q6 Conclude.

↪ Call the professor to cross-check your alignment, observations and measurements.

Off axis analysis of the spot: astigmatism and field curvature

↪ Use the white LED and a $\times 10$ microscope objective.

↪ For field angles ranging from -10 à $+10^\circ$, with increments of $2, 5^\circ$, autour de la position $\theta = 0^\circ$, observe the sagittal and tangential foci and the best focus. Also measure the distances s, c, t of those foci regarding the paraxial focal plane and y' the position of the image in the focal plane.

↪ Write down those measurements in a sheets software to draw the figures.

↪ With the $y' = f' \tan \theta$ method (for small θ i.e. less than 5°), measure the doublet focal length.

Q7 Trace the position of the sagittal focus S the tangential focus T , and the best focus C regarding to the paraxial focal plane as a function of y' .

Q8 Deduce from your measurements the field curvature \mathcal{C} , the sagittal curvature \mathcal{C}_S CS and the tangential curvature \mathcal{C}_T . Deduce from those values the astigmatism coefficient \mathcal{A} . Compare \mathcal{C} and \mathcal{A} to the 3rd order predictions and to the simulations.

↪ Rotate the collimator of exactly 5° . Measure the dimension of the focal segments at sagittal and parraxial foci and the diameter of the spot at best focus. Evaluate the accuracy on your measurements.

Q9 Compare this PSF measurement of the doublet with your previous theoretical prevision.

↪ Place the 12,5 mm diaphragm and measure again the size of the focal segments and the spot diameter at best focus. Evaluate the accuracy of those new measurements.

Q10 Is the result predicted by 3rd order aberration theory?

3.2 Characterization of the magnifying objective

The 150 mm objective is made to project on paper the image of a $24 \text{ mm} \times 36 \text{ mm}$ photography film.

Q11 Calculate the maximum field corresponding to the film size for an object at infinity.

The resolution of argentic films decreases with their sensitivity. The average size of the film grains for argentic films is about $20\ \mu\text{m}$. We also find similar MTF for colored films (see figure 2.7).

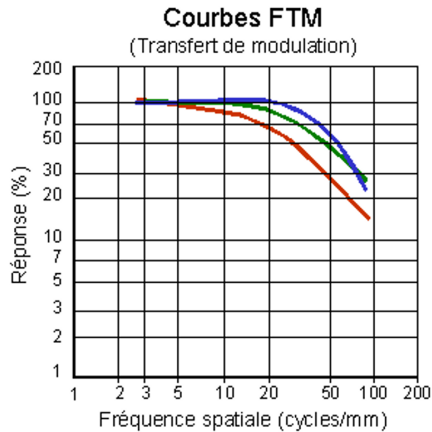

Figure 2.7: MTF for colored films

Q12 Calculate the diameter of the Airy patterns for all the apertures of the magnifying objective and the cut-off frequencies of the associated MTFs.

↪ Place and adjust the magnifying objective on axis and study the optical quality on axis at maximum aperture.

Q13 If the objective have a visible field aberration (coma as an example) on axis, how can we know if it is a misalignment or a defect of the objective?

↪ Measure the dimension of the image spot on axis as a function of the f-number, N .

Q14 Trace the associated figure. Add on the graph the diameter of the Airy pattern.

Q15 Deduce the f-number from which the the objective is diffraction limited on aixe.

↪ Do the same analysis on the edge of the field.

Q16 Conclude. Is this objective quality enough for its application (magnification)?

A 3

ZYGO wavefront analyser

ZYGO is a Fizeau laser interferometer (using an amplitude division) equipped with a phase shift system. It allows to measure wavefront errors down to approximately $\lambda/10$ (PV).

Preparatoy work read carefully the principle of the wavefront measurement method presented in the introductory part and in the text below. Do the preliminary calculations.

Contents

1	Principles	38
2	ZYGO - GPI use	40
3	Lab work	44
	Appendix 1: Phase-shift interferometer	47
	Appendix 2 : Examples of interferograms	49

1 Principles

The schematic diagram of the interferometer is given figure 3.1.

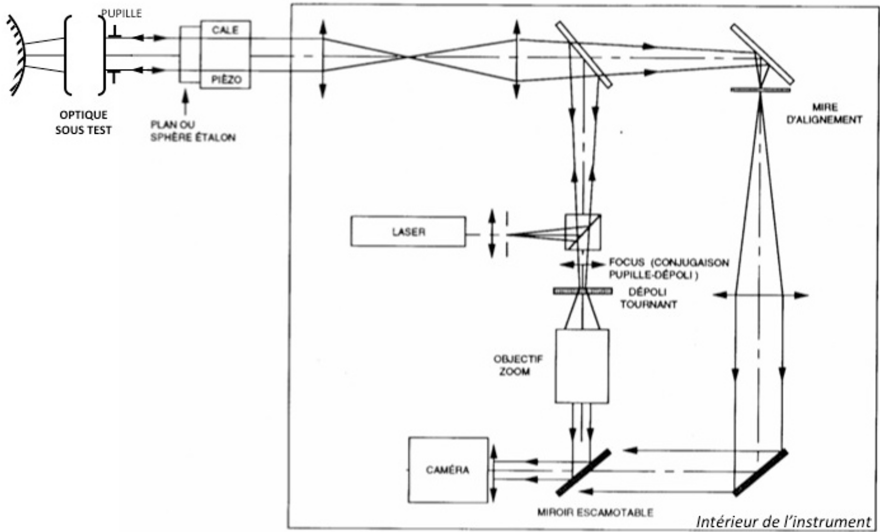

Figure 3.1: Schematic of the ZYGO

The reference flat of the ZYGO is of excellent quality (a few $\lambda/100$ RMS), but is also extremely fragile and expensive. Be very careful and NEVER touch it !

Put the optical system under test far from it and **always put the plastic protection back on the reference flat after use.**

1.1 Interferogram

A perfect lens transforms a plane wavefront into a spherical one: this is known as rigorous stigmatism. If this wave converges at the center of curvature of the reference spherical mirror, the reflected wavefront is again transformed into a plane wavefront. If the adjustment is perfect and if the objective under test is perfectly stigmatic, the Optical Path Delay (OPD) is a constant over the surface of the pupil and the interferogram is uniform, i.e. there is no fringe visible in the interferogram.

For a real lens with aberrations, we observe fringes corresponding to the optical path difference between the real wavefront and the ideal spherical wavefront. This fringe pattern contains information about the geometrical aberrations of the optical system (excluding the chromatic aberrations).

Because the incoming wavefront travels twice through the optical system under test, it experiences the defects of the system twice. Thus, from one white fringe of the interferogram to the next one, the OPD, which is defined as the defect of the wavefront accumulated after one way propagation only, varies by $\lambda/2$. The 3rd order aberrations amplitudes are then calculated by decomposition over Zernike polynomials. The coefficients are calculated as a least square best fit of the wavefront. The software can also simulate the PSF (and the Strehl ratio) and the MTF.

1.2 Fringes visibility

This interferometer uses a monomode stabilized HeNe laser with a long coherence length. Thus, the visibility of the fringes is not limited by spatial nor temporal coherence. The constraints on the reference mirror are then:

- A bigger aperture than the aperture of the optical system.
- For convex mirrors, a smaller radius of curvature than the back focus of the studied objective.
- An optical quality close to the quality of the reference flat.

The light reflection ratio of the reference flat is 4% (glass-air interface). By using non aluminated spherical mirrors the fringes contrast will be excellent. Those fringes are materialized on a rotating frosted glass. The only case when the measurement is impossible with a ZYGO is when the optical quality of the system is too low and thus the wavefront error is wide and the fringes periods are really high, to the point that it becomes higher than the sampling period of the camera.

1.3 Remarks

We effectively measure the objective defects if the spherical mirror and the reference flat have a far better optical quality than the studied objective. For the ZYGO, the reference plane have less than $\lambda/100$ RMS, RMS wavefront error (WFE) and the spherical mirrors have a WFE of about $\lambda/20$ RMS ($\lambda = 632.8$ nm). The only conjugation possible is the image of its center of curvature.

The aberrations are often studied for an infinite-focus conjugation. However, it is possible to study the aberration for finite conjugations using a reference sphere.

PSF and MTF calculations by the software are normalized in regard to the numerical aperture. It is mandatory to indicate the aperture number of the studied objective to the software (f-number).

2 ZYGO - GPI use

2.1 Adjustements of the optical system

The alignment procedure is entirely done with autocollimations.

↪ In 'Align Mode' (**ALIGN**), make sure that the reference flat is well aligned: the retro-reflection should hit the target, on the video monitor.

↪ Place the optical system to test in the chuck, carefully centered on the pupil of the ZYGO and align it by autocollimation using a small flat mirror placed over the mount of the system.

↪ Choose the spherical mirror adapted to the back focus of the optical system.

↪ Ensure that the beam from the optical system is focalized at the center of curvature of the spherical mirror and not at its vertex ! (common mistake). Align the returning beam in ALIGN mode in the cented of the sight using the lateral adjustments of the mirror. The spot should disappear behind the cross of the sight.

↪ Pass in **VIEW** mode to see the fringes.

↪ Adjust, using the **CAM** button of the remote the conjugation between the pupil plane and the rotation frost glass. To do so, try to have the edge of the pupil as sharp as possible. Adjust the **ZOOM** to have the biggest image but without vignetting of the pupil.

↪ With a fine tuning of transverse and longitunal position of the mirror, try to have a flat interferogram or the least number of fringes, which is equivalent to the smallest wavefront error.

2.2 Measure and characterization of the wavefront

The measurement of the wavefront exploits the measurements via a software whose interface window is represented on the figure 3.2.

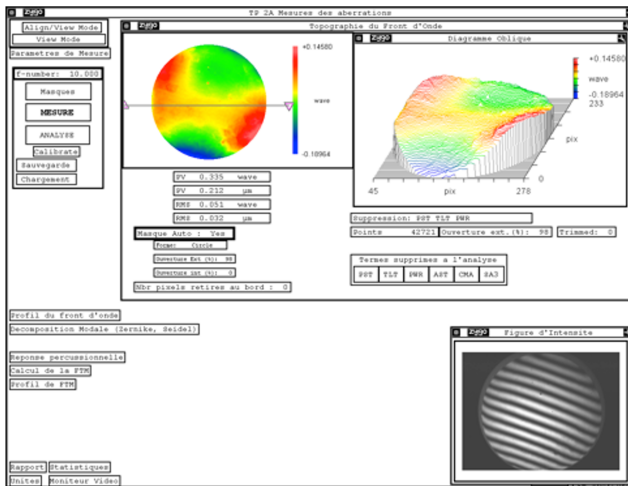

Figure 3.2: Software window

↪ Insert the f-number of the objective under test: it is mandatory to calculate the PSF with a FFT of the wavefront and the MTF by FFT of the PSF.

↪ Launch the wavefront measurement by clicking on **MESURE**.

The software uses a phase-shifting method: it reconstructs the wavefront from the acquisition of 5,7 or 11 interferograms, from different positions of the flat reference.

↪ By default, the software defines a circular mask that covers 98% of the pupil (Masque Auto : Yes). You can visualize the mask in the 'Masque' window (clicking on **MASQUES**) or on the video screen¹.

The Topographie du Front d'Onde window displays the wavefront and the statistics of the wavefront (PV and RMS values). In fact, this is usually not the raw measurement, but the wavefront from which some defects - typically

¹If this mask does not suit you, you can uncheck the automatic definition of the mask, and define it yourself in the Mask window; you must then select Acq (acquisition mask), then define it (Define) using the buttons of the mask definition window.

related to imperfect alignment - have been subtracted, such as piston (PST), wavefront tilt (TLT), wavefront sphericity (PWR) associated with the first four polynomials of the Zernike decomposition.

It is also possible to subtract from the experimental wavefront 3rd order aberrations (spherical aberration: SA3; coma: CMA; astigmatism: AST). The set of subtracted terms are selected by the experimenter in the bar `Terms removed during analysis` of the main window. Note that these six terms are the Seidel sums of the wavefront decomposition, evaluated from the first eight Zernike polynomials according to the relations recalled in the table 3.1.

	C_0	C_1	C_2	C_3												
	Piston	Tilt		Focus												
3 ^{ème} ordre	C_4	C_5	C_6	C_7	C_8											
	Astigmatisme		Coma													
5 ^{ème} ordre	C_9	C_{10}	C_{11}	C_{12}	C_{13}	C_{14}	C_{15}	Aberration sphérique								
7 ^{ème} ordre	C_{16}	C_{17}	C_{18}	C_{19}	C_{20}	C_{21}	C_{22}	C_{23}	C_{24}							
9 ^{ème} + 11 ^{ème} ordre	C_{25}	C_{26}	C_{27}	C_{28}	C_{29}	C_{30}	C_{31}	C_{32}	C_{33}	C_{34}	C_{35}	C_{36}				

Table 3.1: Table of coefficients of the Zernike decomposition displayed by the software

~> You can observe the effect of removing any of these terms on the analyzed wavefront without resuming a measurement, by choosing `ANALYSE`.

The `Décomposition Modale` window displays the first 36 Zernike polynomial coefficients and the Seidel coefficients for 3rd order aberrations. The quality of the fit is also displayed (rms): it corresponds to the RMS value of the residuals. See paragraph 2.3 page 5.

Zernike coefficients are show in a table, in the order above, and are exprimed as wavefront fractions. The calculation is made up to the 9th order (11 for the spherical aberration). The software also gives the root mean square difference (RMS) between the projection and the effective wavefront which gives the accuracy of the Zernike decomposition of the real wavefront.

The Seidel coefficients are evaluated from Zernike coefficients as shown below. Thoses terms are the WFE at the edge of the pupil in wavefront units.

	Amplitude	Angle
TILT	$\sqrt{C_1^2 + C_2^2}$	$\arctan(C_2/C_1)$
FOCUS	$2C_3 - 6C_8$	
ASTIGMATISM	$2\sqrt{C_4^2 + C_5^2}$	$\frac{1}{2} \arctan(C_5/C_4)$
COMA	$3\sqrt{C_6^2 + C_7^2}$	$\arctan(C_7/C_6)$
SPHERICAL	$6C_8$	

Table 3.2: Table of coefficients of the Seidel decomposition

2.3 Result analysis

The window Réponse Percussionnelle (see figure 3.3) calculates the PSF with a FFT from the wavefront and show the PSF (in log scaling) the strehl ratio and the circled energy.

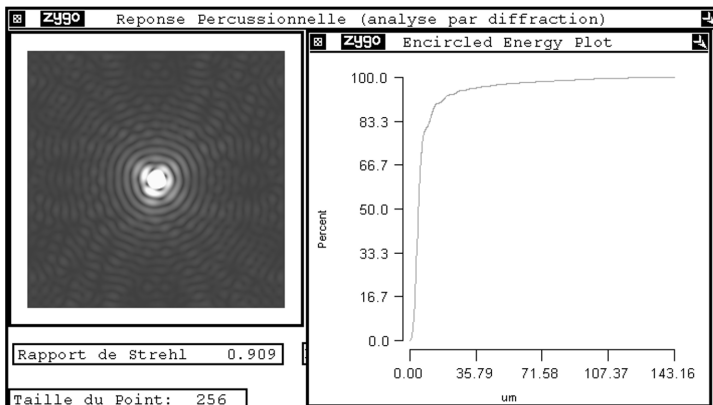

Figure 3.3: Réponse Percussionnelle Window

This window gives you access to the calculation of the encircled energy, i.e. the evolution of the percentage of the total energy included in a circle of given radius, centered on the maximum of the spot, with the radius of this circle. A cursor (right click: »Show Controller) allows to display the value of the circled energy at each point of the curve.

The window `Calcul de la FTM` shows the MTF calculated with a FFT of the PSF. The theoretical cut-off frequency is $1/\lambda N$, calculated from the f-number N given by the user.

3 Lab work

3.1 Singlet characterization

$$f' = 150 \text{ mm}(\pm 1\%) - \emptyset = 25 \text{ mm} - \text{NA} = 0,08.$$

Spherical aberration of the singlet

↪ Place the singlet in the nominal orientation on axis. Adjust its orientation and the convex mirror position to have an interferogram with the smallest number of fringes. Write the f-number of the singlet in the software.

↪ Measure the wavefront error at paraxial focus, best focus and marginal focus.

Q1 For each case, explain where precisely the center of curvature of the spherical mirror is and explain the wavefront error shape (paraxial, marginal and best focus).

Q2 Analyze for each case the PSF and MTF. Explain their signification. Explain how PSF and FTM are calculated by the software.

↪ Measure the caustic length.

↪ Measure the PSF diameter at best focus.

↪ Measure and comment the MTF of the singlet.

↪ Place the 12,5 mm diaphragm and redo the previous measurements.

↪ By dividing the aperture by a factor of 2 (diaphragm of 12.5 mm), do you verify the results of the third order approximation predictions?

3.2 Characterization of the doublet in the nominal orientation

$$f' = 150 \text{ mm}(\pm 1\%) - \emptyset = 25 \text{ mm} - \text{NA} = 0,08.$$

On axis study of the doublet

↪ Place the singlet on axis in the nominal orientation. Adjust its orientation and the convex mirror position to have an interferogram with the smallest number of fringes.

↪ Perform a visual study of the interferogram at the best focus, then with a small defocus before and after the best focus.

Q3 Is the doublet diffraction limited on axis?

↪ Complete your study with a PSF and MTF analysis of the doublet on axis.

Off axis study of the doublet

↪ Rotate the objective around the vertical axis of exactly 2.5° . Observe the different interferograms when the center of the mirror is at the sagittal focus, best focus or tangential focus. Study the associated PSF, the encircled energy diagram and the FTM.

↪ For each position note the astigmatism coefficient and the PSF diameter.

↪ Complete your measurements with measures between -5 et 5° with or without the 12.5 mm diaphragm.

Q4 Compare with the third order approximation predictions.

3.3 Magnifying objective

The 150 mm objective is made to project on paper the image of a 24 mm \times 36 mm photography film.

Q5 Calculate the maximum field corresponding to the film size for an object at infinity.

The resolution of argentic films decreases with their sensitivity. The average size of the film grains for argentic films is about $20\ \mu\text{m}$. We also find similar MTF for colored film (figure 2.7 page 35).

↪ Study with the ZYGO the aberrations of this objective at full aperture both on and off axis (in particular at the edge of the field of $24\ \text{mm} \times 36\ \text{mm}$).

Q6 Give an evaluation of the PSF dimension on axis and at the edge of the field.

↪ Evaluate the MTF of this objective on axis and at the edge of the field.

Q7 What is the 10% cut-off frequency?

Q8 What are the parameters that seem adequate to you to evaluate this objective quality?

Q9 Comment your results taking into account the purpose of this magnifying objective.

Q10 Conclude.

Q11 What are other mandatory measurements to ensure the optical quality of this objective (still taking into account its purpose)?

Appendix 1: Phase-shift interferometer

The ZYGO is a Fizeau interferometer which have a movable reference flat. These moves are controlled displacements by fractions of the wavelength. In a 2 waves interferometer (which is not a multiple waves interferometer ! see below) the illuminance during the translation of the reference plane varies as a sinusoid function of the optical path difference. All phase shift algorithms use this property. The image is numerized (gray levels) for some positions of the reference flat. (An example is given in figure 3.4).

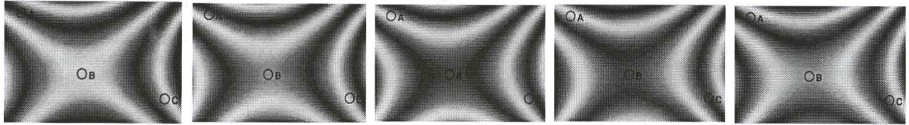

Figure 3.4: Images obtained where there is an astigmatism error and where the reference plane is moved by $\lambda/10$ increments from one image to another)

Important remark: In the Fizeau interferometer, there is always a Fabry-Perot effect between the studied surface and the reference plane, thus a multiple waves interference. In the ZYGO case, the reference plane and the studied objective are not treated. The main interference is then a 2 waves interference as the third one is attenuated by a factor $R^2 = 0.04^2 = 1.6 \cdot 10^{-3}$ regarding the first 2 waves.

The figure 3.5 shows the sinusoidal evolution (period $\lambda/2$) of the gray level for 3 pixels A,B,C corresponding to 3 different points on the interferogram during the displacement of the reference flat.

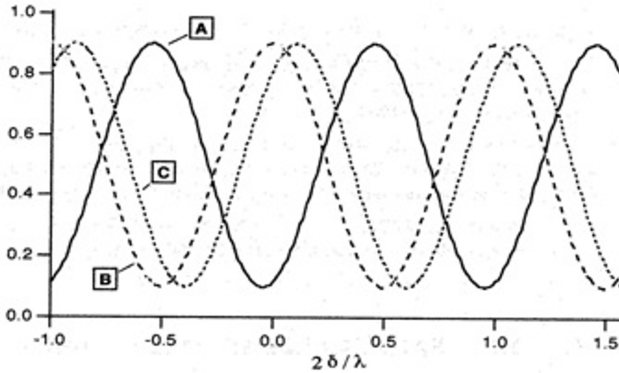

Figure 3.5: Gray level for 3 different pixels A,B,C

The phase difference between those illuminance sinusoids is directly linked to the phase difference on the waves that interfere and thus to the defects of the studied surface. The multiple phase-shift (there are dozens) algorithms aim to determine as precisely as possible this phase difference. The ZYGO use 5 to 11 images of about 220 by 180 points. The huge benefit of the phase-shift method in regard to a classical interferometer is that the error will be measured on each of those $220 \times 180 = 39600$ points !) Using a preliminary calibration the reference plane is translated by precise $\lambda_0/8$ steps (thus a optical path delay variation of $\lambda_0/4$ and a phase difference of $\pi/2$) between each numerization of the interferogram.

The phase determination is given modulo 2π radians. So the phase has to be unwrapped (removing 2π ambiguities). This algorithm is based on the hypothesis that the surface has no 2π , or more, steps (the surface is supposed to be smooth enough). This is a drawback of any interferometric methods (except in white light interferometers).

Appendix 2 : Examples of interferograms and wave-front errors due to 3rd ordre aberrations

Complete the missing labels and values below



Figure 3.6: Out of focus in relation to the paraxial focus (FOCUS = 2λ)



Paraxial focus



Marginal focus

Figure 3.7: Spherical aberration



Paraxial focus



With tilt (best focus)

Figure 3.8: Coma (COMA = λ)



Figure 3.9: Astigmatism (ASTIGMATISM = 3λ). Left: Spherical mirror at the best focus

A 4

HASO wavefront analyzer

The lab report is due the following day at noon. The lab report consists of the result sheet and a short report of maximum 1 page with your analysis and comments (pro/cons of the method). It is necessary to carefully prepare this lab session ahead of time, by reading the introduction of this textbook and answer the preliminary questions.

Contents

1	Description of the instrument	51
2	Experimental setup	58
3	Labwork	61

1 Description of the instrument

1.1 Principle

The HASO4 Broadband USB3 is a Shack-Hartmann type wavefront analyzer. It consists of an array of 68×50 micro-lenses and a $7\text{ mm} \times 5,2\text{ mm}$ CMOS sensor. The CMOS sensor is placed in the focal plane of the micro-lenses. The instrument is illuminated by the wavefront to be analyzed, which is sampled by the micro-lens array. Each micro-lens forms an image spot in the sensor plane. If the incident wavefront is plane and is perpendicular to the lenses axis, each spot will be on the optical axis of the associated micro-lens. On the contrary, if the wavefront is tilted with respect to the micro-lens array or is not a plane, the positions of the spots will depend on the local slope values of the wavefront sampled by each micro-lens. The HASO software measures accurately the mean displacement $(\delta x_n, \delta y_n)$ of each spot with respect to the n -th micro-lens axis (cf. figure 4.1). The wavefront is thus sampled by the

micro-lens array, and the local mean slope on a micro-lens is $\delta\varphi_\nu = \delta x_n/f'$ and $\delta\varphi_\nu = \delta y_n/f'$ in each direction.

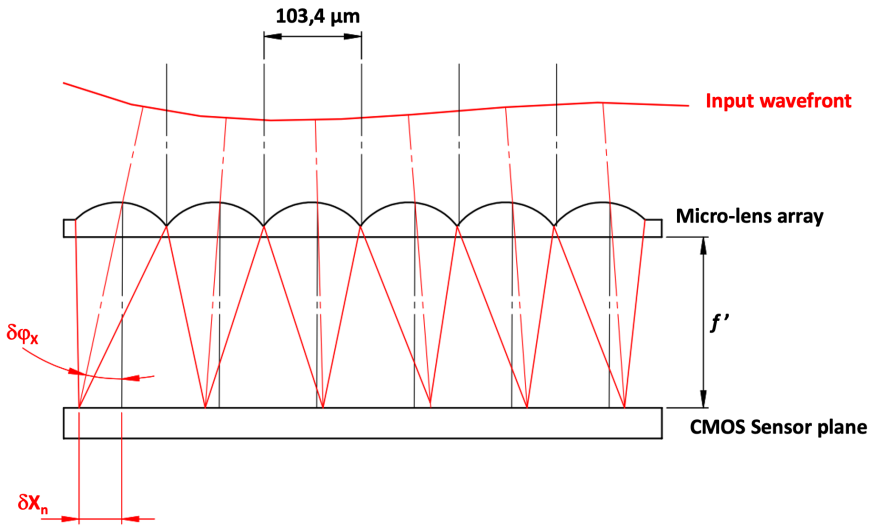

Figure 4.1: Schematic diagram of the wavefront measurement using micro-lenses

The micro-lenses are $103,4 \mu\text{m}$ -square lenses with a $4,8 \text{ mm}$ focal length (*i.e.* the f-number is $N = 46$). The sensor has 1600×1200 square pixels. The pixel size is $4,5 \mu\text{m} \times 4,5 \mu\text{m}$, so that the micro-lens array has almost the same surface as the CMOS chip: each micro-lens is associated to an area of 23×23 adjacent pixels (cf. figure 4.2).

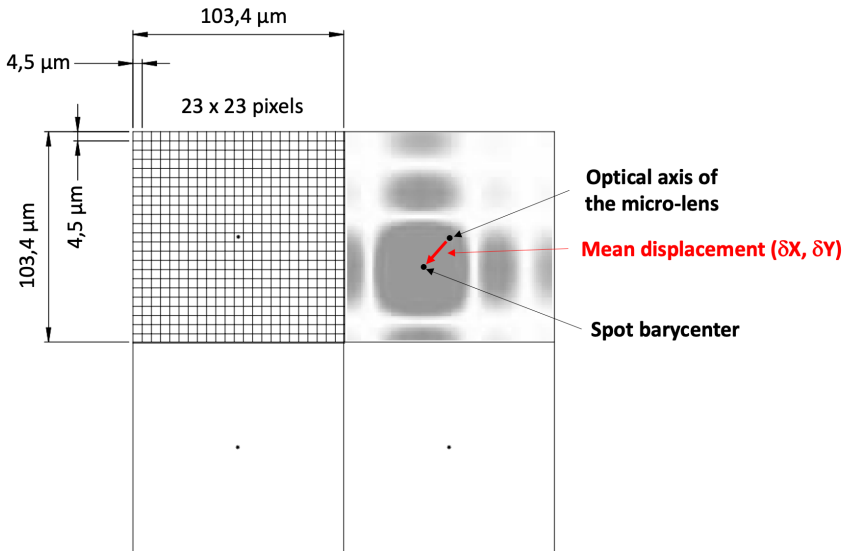

Figure 4.2: Schematic diagram of the displacement measurement

P1 What is the shape and size of the image spot at the focus of a microlens? (it is square pupil !) Compare it to the pixel size of the camera. How many pixels are needed to image the central lobe of the spot?

Remark: The number of pixels in the spot width must be large enough to have a precise measurement of the spot center, but not too large to keep a sufficient flux on each illuminated pixel.

The maximal wavefront tilt the HASO can measure is $\pm 3^\circ$.

P2 What is the associated translation of the image spot regarding the center of each micro-lens ? Compare it to the micro-lens size, and comment.

Remark: Thanks to a clever algorithm, the HASO is capable to associate each spot to the corresponding micro-lens on a much bigger surface than the surface of the micro-lens, which augments the measurement range of the HASO.

1.2 Wavefront measurements

The HASO software displays the values of the local slopes measured right after each micro-lens. The wavefront is deduced from the local slopes either by

direct integration (zonal method) or by decomposition of the whole set of measured slopes over the derivatives of the Zernike polynomials (modal method): we will use the latter in the following.

The software fits the measured wavefront to a sphere (often called the reference sphere). Hence, it calculates the radius of curvature of the wavefront in the plane of the micro-lens array. Knowing the pupil diameter and the radius of this sphere, the HASO software deduces the numerical aperture of the optical system under test, as well as the best focus position (= the center of the reference sphere, which minimizes the root mean square value Δ_{RMS} of the optical path difference). Hence, the reference sphere used by the HASO software is automatically centered on the best focus.

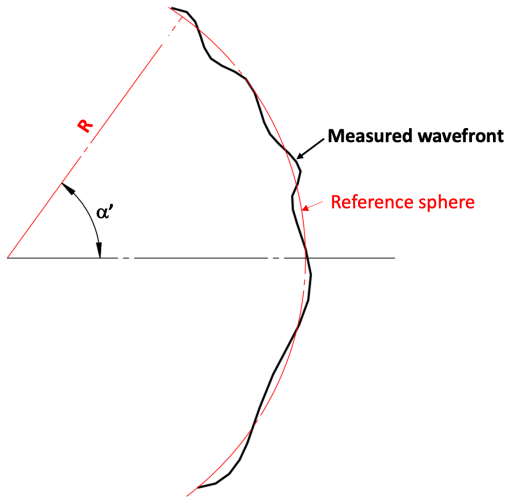

Figure 4.3: Wavefront and reference sphere

The HASO is only able to characterize the wavefront whose numerical aperture is smaller than 0,1.

P3 What is the minimal value of the radius of curvature that can be measured by the instrument?

1.3 Evaluation of the image spot

Like the ZYGO, the HASO software computes the point spread function (PSF) at best focus, the Strehl ratio and the encircled energy, from the Fourier Transform (FFT 2D) of the measured wavefront. The software also computes the

Modulation Transfer Function (cf. paragraph "Wavefront measurements" page 4). The spotdiagram is computed directly from the measured slopes of the wavefront.

1.4 Using the HASO

Presentation of the software for acquisition and analysis

The software *WaveView* (see the user interface window on figure 4.4) allows to acquire the signal and analyze the data, and display them in a friendly and useful way for the optical user. The software can therefore display numerous analysis results, each of them presented in a separated window:

Camera = direct visualization of signal from each sensor pixel.

Local slopes = local slope of the wavefront on each micro-lens, which is determined using the displacement vector from the optical axis of the micro-lens to the barycenter of the associated image spot.

Intensity = light intensity integrated on each micro-lens and determined by summing the values of all the pixels located in the associated image spot.

Wavefront = measured mean wavefront

PSF = point spread function at best focus. Strehl ratio and encircled energies (at 84%) are also displayed.

MTF = 2D modulation transfer function, and two MTF profiles corresponding to two directions.

Modal Coefficients = values of the first 32 normalized Zernike coefficients (the number of displayed coefficients is configurable)

Parameters = X and Y tilts, and radius of curvature of the wavefront for the chief ray; values of X and Y defocus with respect to the reference sphere.

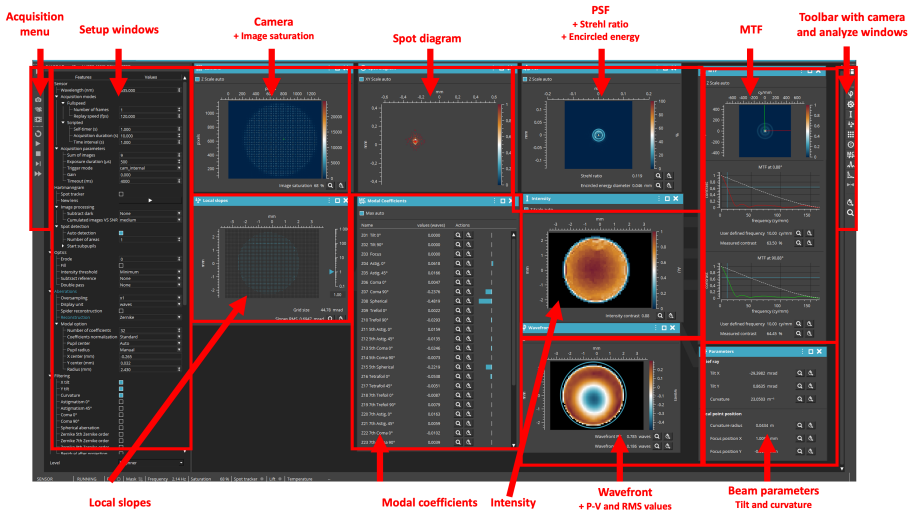

Figure 4.4: User interface window

Lighting and exposure time

Ideally, the CMOS camera working point is near the saturation threshold (saturation > 90%). The Exposure duration may be adjusted in the Setup Window: Sensor / Acquisition parameters / Exposure time (μs).

The HASO is really sensitive to stray light. Please pay attention to keep a high saturation level and reduce the light level in the lab room.

Starting a new acquisition

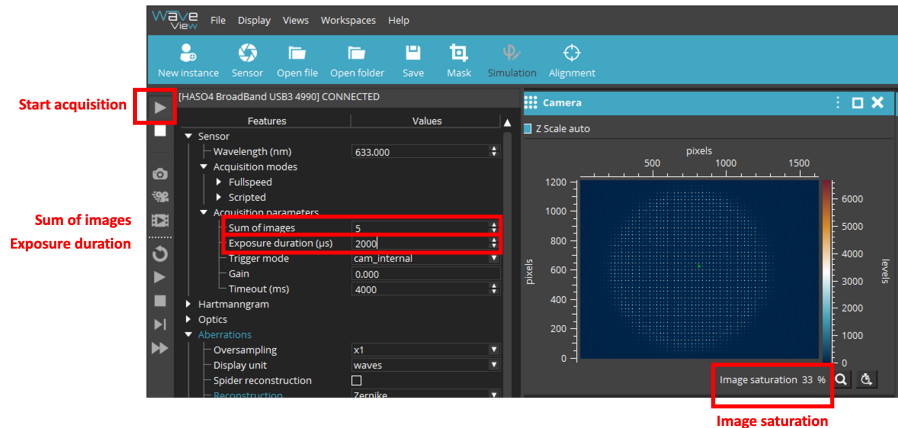



Figure 4.5: Window, useful menus to launch the acquisition

↪ Start the acquisition () and check that the saturation level of the camera is correct. If needed, adjust the saturation with the parameter `Exposure duration` or with the laser diode intensity.

↪ Open the camera window (button  in the right-hand toolbar). This window always opens first, and should stay visible in order to adjust the camera position (with transverse and longitudinal translations) so that the beam is centered on the detector and fully included in the micro-lens array.

The analysis pupil can be computed automatically (we will use this solution during this lab session), or be set manually (in the left panel, select `Aberrations / Modal option / Pupil center et Pupil radius`).

↪ To correctly visualize the analysis results, we can remove the tilt and curvature terms that are not intrinsic to the optical system to test but are directly related to the HASO positioning with respect to the beam (see left panel, under `Filtering / X tilt, Y tilt et Curvature`).

Remark: to simplify the start of this lab work, you can use the `TP_2A` session specifically set up for this work. This session sets the value of the beam wavelength, defines automatically the analysis pupil, imposes the modal decomposition of the wavefront, and removes the values of tilt and curvature of

the wavefront form the analysis. This session can be selected in the drop-down menu `Workplace` in the top right corner. In case you closed an analysis window in the session, you can reopen it by clicking on the buttons in the toolbar on the right:

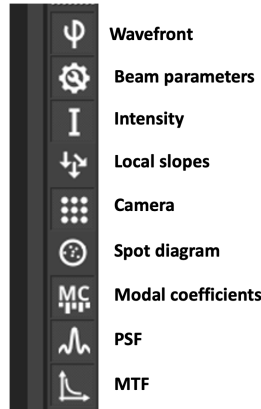

Figure 4.6: Right-side toolbar

2 Experimental setup

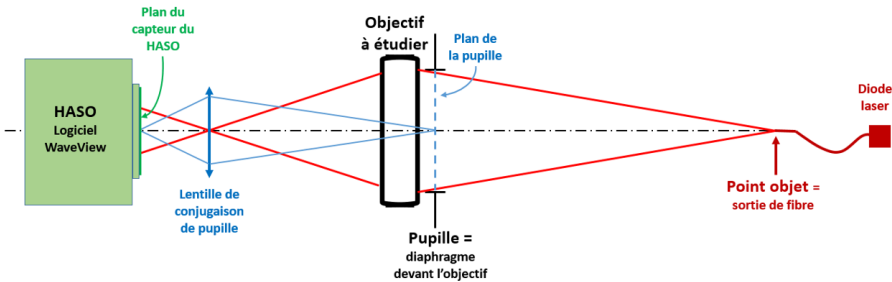

Figure 4.7: Experimental setup

The light source is a laser diode emitting at $\lambda = 635 \text{ nm}$. The **object point** is generated by the output of the transverse optical fiber. The mode diameter of the fiber is of $4,3 \mu\text{m}$ at 635 nm and its numerical aperture is of 0.10. The fiber is coupled with a stabilized power source (in intensity, $I_{\text{max}} = 40 \text{ mA}$). The intensity must be adjusted to reach the needed illuminance value.

The objective to test is a doublet Thorlabs AC254-150-A1 with a 150 mm focal length and a 25 mm diameter. It is equipped with an iris diaphragm of variable diameter. This diaphragm is the entrance pupil of the setup.

The mechanical mounting of the doublet allows to adjust its orientation with respect to the source.

The HASO is mounted on transverse- (X, Y) translation stages to center its pupil on the beam. The instrument can also be translated on a rail along Z (the direction of beam propagation) to ensure that the whole beam enters the HASO.

The pupil conjugation is realized by a lens that conjugates the pupil plane¹ with the HASO sensor. This lens introduces no (or very little) additional aberration on the wavefront being studied, as it is placed in the image plane of the test lens. The role of this pupil conjugation is twofold:

- To observe the wavefront as if it were in the plane of the entrance pupil, i.e. without any propagation effects between the pupil and the HASO. These effects, linked to diffraction, can have non-negligible contributions on the wavefront, compared to the contribution introduced by the objective to be studied. Carrying out this study without pupil conjugation

¹As the diaphragm (= entrance pupil) is very close to the objective under study, its image by the objective is almost identical to itself. The intermediate pupil (= image of the entrance pupil by the objective under study) is therefore almost superimposed on the entrance pupil.

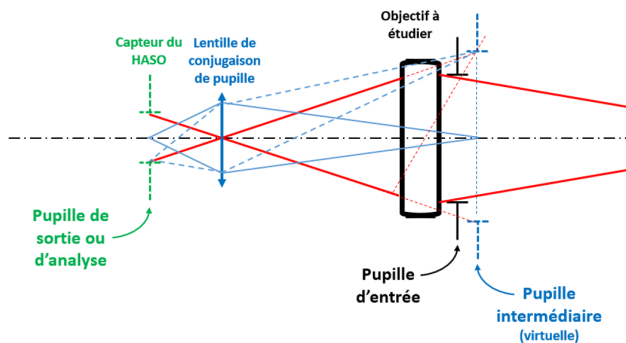

Pupil conjugation consists of imaging the plane of the entrance pupil onto the sensor (= plane of the exit pupil), but formally, the pupil conjugation lens only conjugates the plane of the intermediate pupil with the sensor.

could distort the results and make the wavefront measurement dependent on where the HASO is placed.

- To guarantee homogeneous illumination of the microlens array, enabling the WaveView software to define a perfectly stable analysis pupil, since this analysis pupil is nothing other than the image of the entrance pupil.

It should be borne in mind that pupil conjugation produces a true image of the entrance pupil on the HASO, with a magnification that depends on the focal length of the conjugating lens. Ideally, therefore, the focal length of this lens (and the magnification of this imaging) should be changed as the diameter of the entrance diaphragm is reduced, in order to make the best possible use of the 5 x 7 mm micro-lens screen. For the purposes of this lab session, the focal length of the conjugating lens is fixed at 30 mm, giving a magnification between the entrance and exit pupils of approximately -0.15. For small input diaphragm diameters, the analysis pupil becomes too small, too few micro-lenses are illuminated and the wavefront becomes undersampled.

A **microscope** equipped with a camera will be used to compare the HASO measurements with the shape of the real image spot. You can switch from one to the other using the moveable mirror.

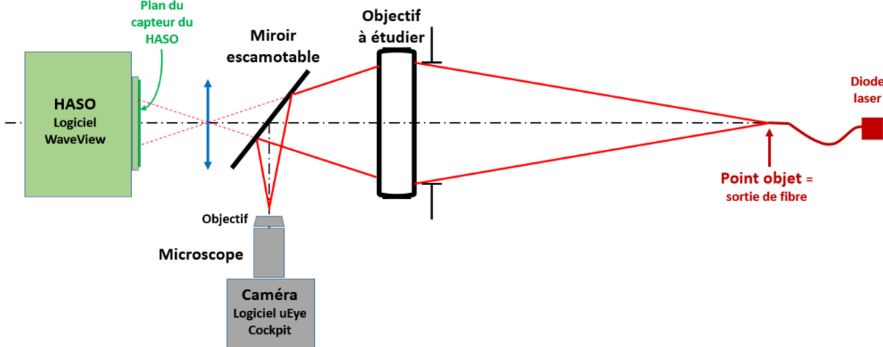

Figure 4.8: Montage expérimental de caractérisation de l'objectif avec microscope

The objective has been optimized for an infinite/finite conjugation. However, during this lab session, it will be characterized for a **finite/finite conjugation with a magnification of $g_y = -1/3$** .

P4 What is the distance between the objective and the fiber output, which ensures this magnification factor (the objective will be approximated as a thin lens)?

Q1 Evaluate for each aperture diameter 25, 20, 15, 10 and 5mm the real working numerical aperture of the objective.

Q2 What are the corresponding Airy diameters?



3 Labwork

During this lab session, you will characterize an objective working at finite image distance, using the wavefront analysis method with the `HASO`. You can use the moving mirror to visualize the image spot using a microscope and a camera (point source method), and check that your observations are coherent with the results given by the `HASO`. The image of the camera can be displayed using the `IDS peak Cockpit` software.

3.1 On-axis study of the objective using the `HASO`

Positioning the objective

↪ Adjust the objective position with respect to the source, so that the magnification is $-1/3$.

↪ Ensure that the retractable mirror is not in the beam path and launch the `WaveView` software. Open the `TP2A` session and start acquisition (). Look at the 'Camera' window (). Position the `HASO` together with its pupil conjugating lens so that the conjugating lens is placed on the image point (adjust it by eye or with a ruler). Adjust the position of the `HASO` (transverse translations) so that the beam is correctly centred on the sensor.

↪ By looking at the values of Zernike coefficients (`Modal coefficients` window, adjust the orientation of the objective to set the object point (output of the fiber) on the optical axis of the objective. The coefficients related to field aberrations need therefore to be minimized.

Experimental measurement of the PSF of a micro-lens

↪ In the `Camera` window, zoom in on the image spot of a micro-lens, and estimate its dimension in pixels. Compare your result with the dimension of the PSF on a micro-lens calculated in **P1**. Remember that the pixel size is of 4,5 μm .

On-axis characterization of the objective at full aperture

Using local slopes To see the whole coefficients of the wavefront, the tilt and focus need to be taken into account:

↪ In the left panel under `Filtering` uncheck the terms `X tilt`, `Y tilt` and `Curvature`.

↪ Enlarge the local slope window () and adjust the gain (= scale on the right side of the window `Local slopes`) to clearly see the displacement vectors.

Q3 Is the wavefront coming on HASO divergent or convergent? What do the tilt and curvature refer to? Why should we remove them to analyze the aberrations of the optical system?

↪ Re-check the terms `X tilt`, `Y tilt` and `Curvature` to remove them. Re-adjust the gain to clearly see the displacement vectors without tilt and focus. By observing the residual slope, deduce the predominant aberration.

Remark: Though the slopes are the only information available for the HASO, analyzing them is neither intuitive nor quantitative for the optical user. This is why the `WaveView` software makes different analysis tools available (decomposition on Zernike basis, wavefront map, PSF, MTF, Strehl ratio, encircled energy, ...). We will use these tools in the following to characterize the objective.

Using the analysis tools

↪ Open the `PSF` window and observe the shape of the PSF, the Strehl ratio and the encircled energy. Make sure that these values are calculated at best focus by adjusting the `Defocus` value. Study how these quantities vary as a function of the aperture of the diaphragm. Compare your measurements with the Airy spot diameters calculated in **Q2**.

Q4 For which aperture the objective is diffraction-limited? According to which criterion?

↪ By analyzing the shape of the wavefront (`Wavefront windows`) and the Zernike coefficients (`Modal coefficients window`), identify the predominant aberration when the objective is not diffraction-limited.

Q5 How do these aberrations evolve with respect to the aperture of the objective? Is this evolution consistent with the theory?

Q6 A very useful way to present the results is to plot the PSF diameter with respect to:

$$N_{\text{image}} = \frac{1}{2 \sin(\alpha')}$$

Remark: The encircled energy of 86% corresponds to a very good approximation of the PSF diameter.

Q7 On the same graph, plot the theoretical Airy spot diameter (it must be a linear function).

Q8 Infer from this graph the value of the f-number, from which the objective is diffraction-limited on axis, and the f-number value providing the best resolution (*i.e.* the smallest PSF diameter).

3.2 On-axis study of the objective using the microscope

↪ Insert the moving mirror in the beam path. Selected a microscope objective adapted to this characterization. Start the `IDS peak Cockpit` software. Position the microscope to observe the image spot at the beam focus point.

↪ Observe this image spot when the objective is fully opened.

Q9 Are the shape of this spot and its evolution when adding a slight defocus around the best focus consistent with the results obtained with the `HASO`?

↪ Measure the PSF diameter. To do so, you can use the `cursor` tool to point on the edges of the PSF image and get their positions in pixels (see figure 4.9). The pixel size of the camera is $1,45 \mu\text{m}$.

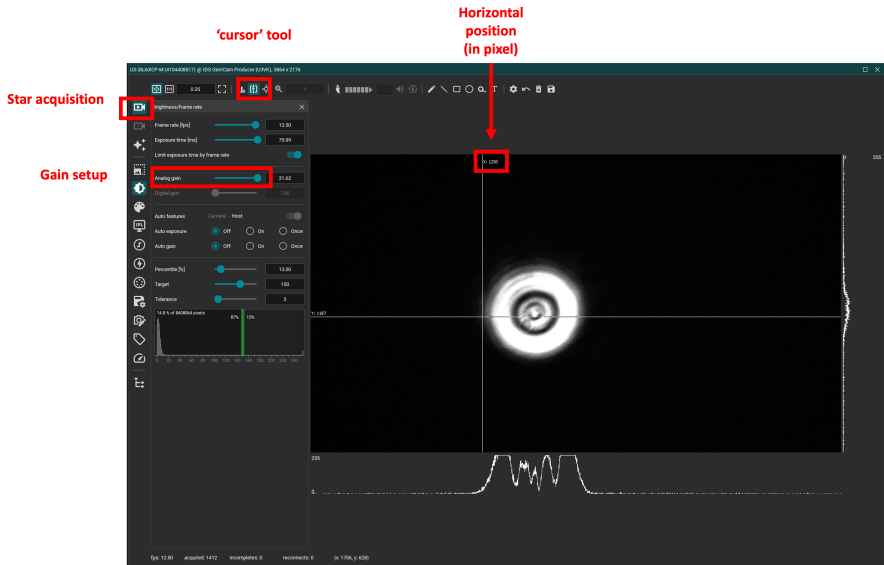

Figure 4.9: Measuring the PSF diameter

↪ Gradually close the diaphragm.

Q10 What is the maximal aperture for which the objective is diffraction-limited? What is the PSF diameter then? Compare it with the result obtained with the HASO.

3.3 Off-axis study of the objective using the HASO

The field angle of the objective will be fine tuned using a rotation stage equipped with a vernier, placed under the objective mounting.

The goal of this section is to add to the latter graph similar curves plotted for different field angles.

↪ For several field angles from -4° to $+4^\circ$, characterize the doublet (wavefront shape, predominant aberration, PSF diameter, Strehl ration, and encircled energy) by changing the aperture of its iris diaphragm. Focus on:

- the evolution of the Zernike coefficients of the predominant 3th order aberrations,
- the variations of shape and size of the PSF.

Q11 Add your PSF (or encircled energy) measurements off-axis to the on-axis graph.

Q12 Why is the PSF calculation by `WaveView` impossible when the field angle is too large?

3.4 Off-axis study of the objective using the point source

↔ Replace the moving mirror, and observe the image spot using the microscope for field angles of $+2^\circ$ and $+4^\circ$, at full aperture. Measure the corresponding PSF dimensions.

Q13 Why cannot the `HASO` perform any proper analysis if the field angle and/or the aperture are too high? Compare the PSF obtained with the `HASO` and the microscope, and indicate if the measurement using the `HASO` was correct.